

ALTO-SHAAM®

Holding Cabinet Electronic or Manual Control



1200-UP



Models:
1200-S
1200-UP



1200-S

PLATON SERVICE
8 (800) 500-34-47
www.platonservice.com

- **INSTALLATION**
- **OPERATION**
- **MAINTENANCE**

HALO HEAT®

24•7
Your Service Hotline
1-800-558-8744

W164 N9221 Water Street • P.O. Box 450 • Menomonee Falls, Wisconsin 53052-0450 USA
PHONE: 262.251.3800 • 800.558.8744 USA/CANADA FAX: 262.251.7067 • 800.329.8744 U.S.A. ONLY
www.alto-shaam.com

ALTO-SHAAM®

Delivery	1
Unpacking	1
Safety Procedures and Precautions	2

Installation

Installation Requirements	3
Clearance Requirements	3
Dimension Drawings, weights & capacities	4
Options and Accessories	5
Universal Pan Slides/Side Racks and Shelves	6
Leveling	7
Restraint Requirements - Mobile Equipment	7
Electrical Specifications	8
User Safety Information	9
Before Initial Use	9
Heating Characteristics	9

Operating Instructions

Manual Control Operation	10
Electronic Control Identification	11
Electronic Control Set-Up	12
Electronic Control Operation	12
Electronic Holding Cabinet Special Features	13
Heat Recovery	13
HACCP Documentation	13
HACCP Documentation w/ Kitchen Management	13
Dough Proofing Instructions	13
Electronic Control Timer Programming	14
General Holding Guidelines	15

Care and Cleaning

Cleaning and Preventative Maintenance	16
Protecting Stainless Steel Surfaces	16
Cleaning Agents	16
Cleaning Materials	16
Clean Daily	17

Sanitation

Sanitation/Food Safety	18
Internal Food Product Temperatures	18

Service

Thermostat Accuracy	19
Trouble Shooting - MANUAL CONTROL	20
Trouble Shooting - ELECTRONIC CONTROL	21
Exterior Service View - 1200-S	22
Exterior Service View - 1200-UP	23
Exterior Service Parts List	24
Cable Heating Kits	24
Bonnet Assembly View - Manual Control	25-26
Bonnet Assembly Parts List - Manual Control	27
Bonnet Assembly View - Electronic Control	28
Bonnet Assembly Parts List - Electronic Control	29

Wire Diagrams

1200-S, 120V - MANUAL	30
1200-S, 208-240V - MANUAL	31
1200-S, 230V - MANUAL	32
1200-S, 120V - ELECTRONIC	33
1200-S, 208-240V - ELECTRONIC	34
1200-S, 230V - ELECTRONIC	35
1200-UP, 120V - MANUAL	36
1200-UP, 208-240V - MANUAL	37
1200-UP, 230V - MANUAL	38
1200-UP, 120V - ELECTRONIC	39
1200-UP, 208-240V - ELECTRONIC	40
1200-UP, 230V - ELECTRONIC	41

Warranty

Transportation Damage and Claims	Back Cover
Limited Warranty	Back Cover

ALTO-SHAAM®

DELIVERY

This Alto-Shaam appliance has been thoroughly tested and inspected to insure only the highest quality unit is provided. Upon receipt, check for any possible shipping damage and report it at once to the delivering carrier. See *Transportation Damage and Claims section located in this manual.*

This appliance, complete with unattached items and accessories, may have been delivered in one or more packages. Check to ensure that all standard items and options have been received with each model as ordered.

Save all the information and instructions packed with the appliance. Complete and return the warranty card to the factory as soon as possible to assure prompt service in the event of a warranty parts and labor claim.

This manual must be read and understood by all people using or installing the equipment model. Contact the Alto-Shaam service department if you have any questions concerning installation, operation, or maintenance.

NOTE: All claims for warranty must include the full model number and serial number of the unit.

UNPACKING

1. Carefully remove the appliance from the carton or crate.

NOTE: Do not discard the carton and other packaging material until you have inspected the unit for hidden damage and tested it for proper operation.

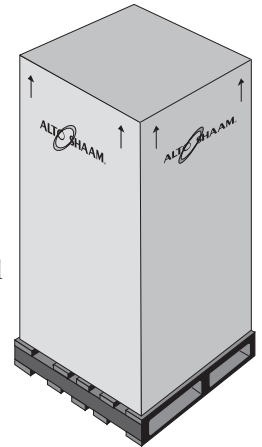

2. Read all instructions in this manual carefully before initiating the installation of this appliance.

DO NOT DISCARD THIS MANUAL.

This manual is considered to be part of the appliance and is to be provided to the owner or manager of the business or to the person responsible for training operators. *Additional manuals are available from the Alto-Shaam service department.*

3. Remove all protective plastic film, packaging materials, and accessories from the appliance before connecting electrical power. Store any accessories in a convenient place for future use.

SAFETY PROCEDURES AND PRECAUTIONS

Knowledge of proper procedures is essential to the safe operation of electrically and/or gas energized equipment. In accordance with generally accepted product safety labeling guidelines for potential hazards, the following signal words and symbols may be used throughout this manual.

DANGER



Used to indicate the presence of a hazard that **WILL** cause severe personal injury, death, or substantial property damage if the warning included with this symbol is ignored.

WARNING



Used to indicate the presence of a hazard that **CAN** cause personal injury, possible death, or major property damage if the warning included with this symbol is ignored.

CAUTION



Used to indicate the presence of a hazard that can or will cause minor or moderate personal injury or property damage if the warning included with this symbol is ignored.

CAUTION

Used to indicate the presence of a hazard that can or will cause minor personal injury, property damage, or a potential unsafe practice if the warning included with this symbol is ignored.

NOTE: Used to notify personnel of installation, operation, or maintenance information that is important but not hazard related.

1. This appliance is intended to cook, hold or process foods for the purpose of human consumption. No other use for this appliance is authorized or recommended.
2. This appliance is intended for use in commercial establishments where all operators are familiar with the purpose, limitations, and associated hazards of this appliance. Operating instructions and warnings must be read and understood by all operators and users.
3. Any troubleshooting guides, component views, and parts lists included in this manual are for general reference only and are intended for use by qualified technical personnel.
4. This manual should be considered a permanent part of this appliance. This manual and all supplied instructions, diagrams, schematics, parts lists, notices, and labels must remain with the appliance if the item is sold or moved to another location.

NOTE



For equipment delivered for use in any location regulated by the following directive:

DO NOT DISPOSE OF ELECTRICAL OR ELECTRONIC EQUIPMENT WITH OTHER MUNICIPAL WASTE.

INSTALLATION

DANGER



IMPROPER INSTALLATION, ALTERATION, ADJUSTMENT, SERVICE, OR MAINTENANCE COULD RESULT IN SEVERE INJURY, DEATH OR CAUSE PROPERTY DAMAGE.

READ THE INSTALLATION, OPERATING AND MAINTENANCE INSTRUCTIONS THOROUGHLY BEFORE INSTALLING OR SERVICING THIS EQUIPMENT.

CAUTION



TO PREVENT PERSONAL INJURY, USE CAUTION WHEN MOVING OR LEVELING THIS APPLIANCE.

CAUTION



METAL PARTS OF THIS EQUIPMENT BECOME EXTREMELY HOT WHEN IN OPERATION. TO AVOID BURNS, ALWAYS USE HAND PROTECTION WHEN OPERATING THIS APPLIANCE.



DANGER



DO NOT store or use gasoline or other flammable vapors or liquids in the vicinity of this or any other appliance.

SITE INSTALLATION

The Alto-Shaam cook and hold oven must be installed in a location that will permit the oven to function for its intended purpose and to allow adequate clearance for ventilation, proper cleaning, and maintenance access.

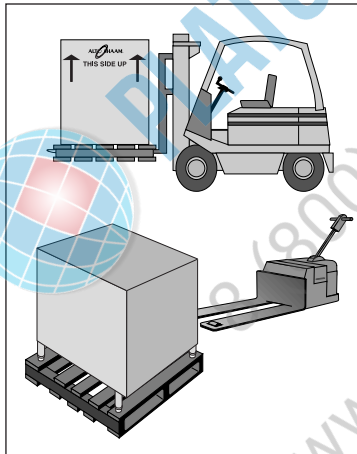

Emissions testing conducted by Underwriters Laboratories, Inc.® was found to be in compliance with the applicable requirements of NFPA96: 2004 Edition, Par. 4.1.1.2. U.L emissions sampling of grease laden vapor resulted in a total of 0.55 milligrams per cubic meter with no visible smoke and is considered representative of all oven models in the line. Based on these results, hood installation and/or outside venting should not be a requirement in most areas. Verify local codes for locations where more restrictive codes are applicable.

1. The oven must be installed on a stable and level surface.
2. **DO NOT** install this appliance in any area where it may be affected by any adverse conditions such as steam, grease, dripping water, high temperatures, or any other severely adverse conditions.
3. **DO NOT** store or use any flammable liquids or allow flammable vapors in the vicinity of this oven or any other appliance.
4. This appliance must be kept free and clear of any combustible materials.
5. This appliance must be kept free and clear of any obstructions blocking access for maintenance or service.

MINIMUM CLEARANCE REQUIREMENTS

BACK	3" (76mm)
LEFT SIDE	1" (25mm)
RIGHT SIDE	1" (25mm)
TOP	2" (51mm)

NOTE

If the appliance has been unplugged for an extended period of time, the Real Time Clock may require recharging. Plug the unit into the proper receptacle for a minimum of 24 hours.

INSTALLATION

Model 1200-UP

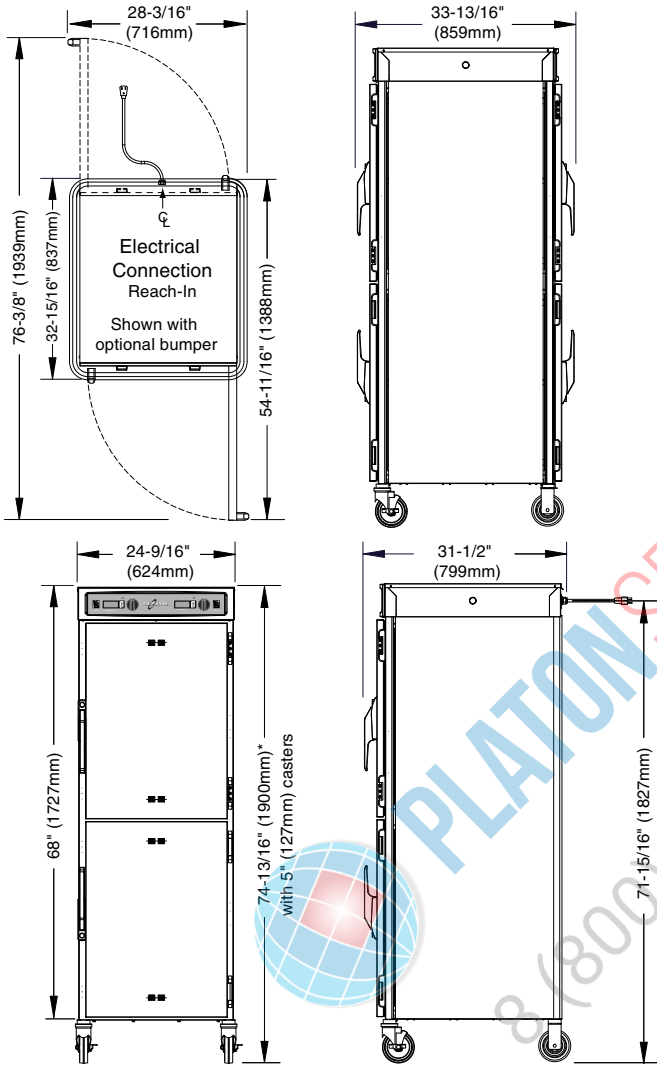

*73-7/16" (1864mm) - with optional 3" (76mm) casters
 *75-3/4" (1924mm) - with optional 6" (152mm) legs

Model 1200-S

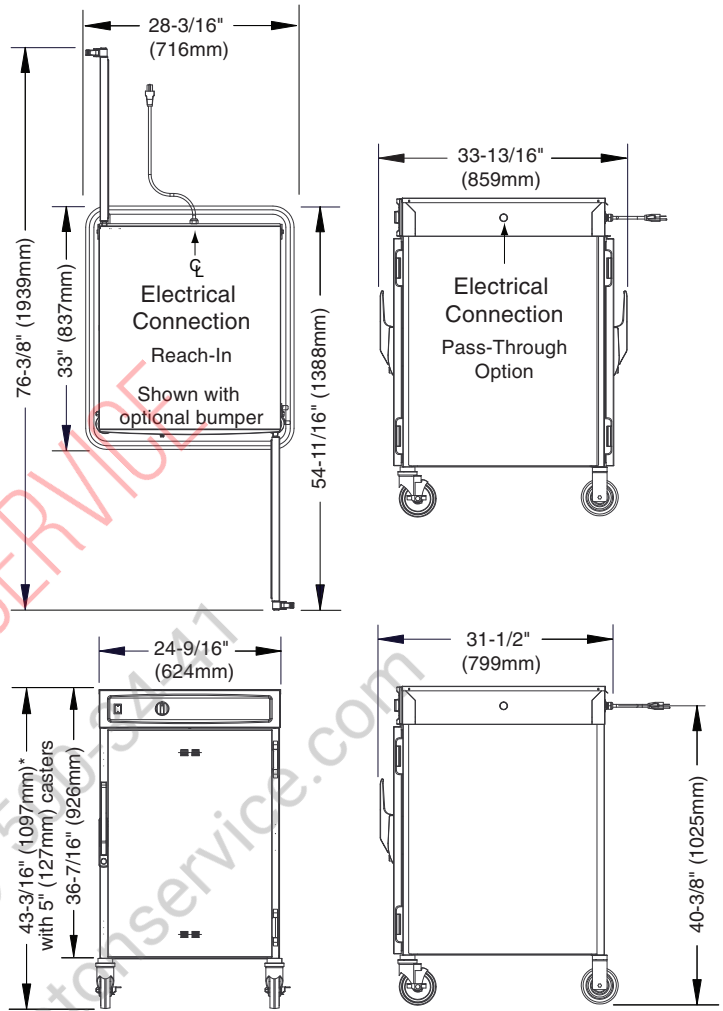

*41-1/16" (1043mm) - with optional 3" (76mm) casters
 *43-5/16" (1099mm) - with optional 6" (152mm) legs

WEIGHTS AND CAPACITIES

WEIGHT - 1200-S

	1200-S/STD	1200-S/HD
NET	165 lb (75kg)	180 lb (82kg)
SHIP	205 lb (93kg)	225 lb (102kg)
CARTON DIMENSIONS: (H x W x D) 50" x 35" x 35" (1270mm x 889mm x 889mm)		

WEIGHT - 1200-UP

	1200-UP/STD	1200-UP/HD
NET	276 lb (125kg)	301 lb (137kg)
SHIP	315 lb (142kg)	350 lb (159kg)
CARTON DIMENSIONS: (H x W x D) 82" x 35" x 35" (2083mm x 889mm x 889mm)		

PRODUCT/PAN CAPACITY (PER COMPARTMENT)

192 lbs (87kg) MAXIMUM		
VOLUME MAXIMUM: 120 QUARTS (152 LITERS)		
—WITH PAN SLIDES PROVIDED:		—WITH ADDT'L PAN SLIDES:
	FULL-SIZE PANS:	GASTRONORM 1/ 1:
Eight (8)	20" x 12" x 2-1/2"	(530 x 325 x 65mm) up to 16 Pans
Eight (8)	20" x 12" x 4"	(530 x 325 x 100mm) up to 10 Pans
Eight (8)	20" x 12" x 6"	(530 x 325 x 150mm)
	FULL-SIZE SHEET PANS:	
Four (4)	18" x 26" x 1"	up to 16 Pans
UNIVERSAL PAN SLIDES - 1-3/4" (44mm) CENTERS		
—WITH OPTIONAL SIDE RACKS FOR SHELVES		
	FULL-SIZE PANS:	GASTRONORM 1/ 1:
Sixteen (16)	20" x 12" x 2-1/2"	(530 x 325 x 65mm)
Ten (10)	20" x 12" x 4"	(530 x 325 x 100mm)
Eight (8)	20" x 12" x 6"	(530 x 325 x 150mm)

INSTALLATION

OPTIONS and ACCESSORIES

	1200-S	1200-UP
Electronic Control (FACTORY INSTALLATION ONLY)	AVAILABLE	AVAILABLE
Computer Software (ELECTRONIC CONTROL ONLY) HACCP DOCUMENTATION HACCP & KITCHEN MANAGEMENT NETWORKING	REFER TO SPECIFICATION #9015, FOR APPLICABLE PART NUMBERS	
Bumper, Full Perimeter	5010295	5010295
Caster Package, 3" (76mm)	5010293	5010293
Door Assembly, Window (FACTORY INSTALLATION ONLY)	5005142	5005142
Door Lock with Key	LK-22567	LK-22567
Handle Kit, Push/Pull (SET OF FOUR)	55662	55662
Legs, 6" (152mm)	5010294	5010294
Pan Grid, Wire 18" x 26" (457mm x 660mm)	PN-2115	PN-2115
Pass-Through Design	AVAILABLE	AVAILABLE
Probe, internal product temperature (ELECTRONIC CONTROL)	AVAILABLE	AVAILABLE
Shelf, Chrome Plated Wire, for side racks	SH-2733	SH-2733
Shelf, Stainless Steel Wire, for side racks	SH-23738	SH-23738
Side Rack Model	AVAILABLE	AVAILABLE
Stacking Hardware	5010295	N/A
Universal Angle Pan Slides, Chrome	SR-24447	SR-24447
Universal Angle Pan Slides, Stainless Steel	SR-24762	SR-24762
Water Reservoir, Pan	1775	1775
Water Reservoir, Cover	1774	1774

INSTALLATION

UNIVERSAL PAN SLIDES

As an alternative to universal pan slides, the 1200-UP model can be ordered as a "side rack" model which is equipped with two (2) side racks and three (3) chrome plated wire shelves per compartment.

Universal Pan Slides,
chrome plate
SR-24447

Side Rail
16046



SIDE RACKS AND SHELVES

Model 1200-UP that has been converted with side racks to accommodate full and half size U.S. Hotel and European Gastronorm pans or sheet pans on the side racks.

Shelf
SH-23738, stainless steel
or SH-2733, chrome plate

Side Rack
SR-25271



DANGER



**DISCONNECT UNIT FROM
POWER SOURCE BEFORE
CLEANING OR SERVICING.**

CAUTION



**TO PREVENT PERSONAL INJURY,
USE CAUTION WHEN MOVING OR
LEVELING THIS APPLIANCE.**

INSTALLATION

SITE INSTALLATION

A number of adjustments are associated with initial installation and start-up. It is important that these adjustments be conducted by a qualified service technician. Installation and start-up adjustments are the responsibility of the dealer or user. These adjustments include but are not limited to thermostat calibration, door adjustment, leveling, electrical hook-up and installation of optional casters or legs.

LEVELING

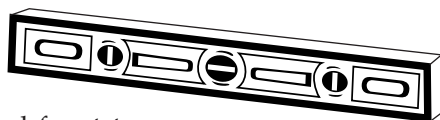

Level the oven from side-to-side and front-to-back with the use of a spirit level. For ovens installed with casters, it is important that the installation surface be level due to the probability of frequent oven repositioning.

We recommend checking the level of the oven periodically to make certain the floor has not shifted nor the oven moved.

NOTE: Failure to properly level this oven can cause improper function and will result in the uneven baking with products consisting of semi-liquid batter.

RESTRAINT REQUIREMENTS —MOBILE EQUIPMENT

 WARNING	
	RISK OF ELECTRIC SHOCK. Appliance must be secured to building structure.

Any appliance that is not furnished with a power supply cord but that includes a set of casters must be installed with a tether. Adequate means must be provided to limit the movement of this appliance without depending on or transmitting stress to the electrical conduit. The following requirements apply:

1. Maximum height of casters is 6" (152mm).
2. Two of the casters must of be the locking type.
3. Such mobile appliances or appliances on mobile stands must be installed with the use of a flexible connector secured to the building structure.

A mounting connector for a restraining device is located on the lower back flange of the appliance chassis or on an oven stand, approximately 18" (457mm) from the floor. A flexible connector is not supplied by nor is it available from the factory.

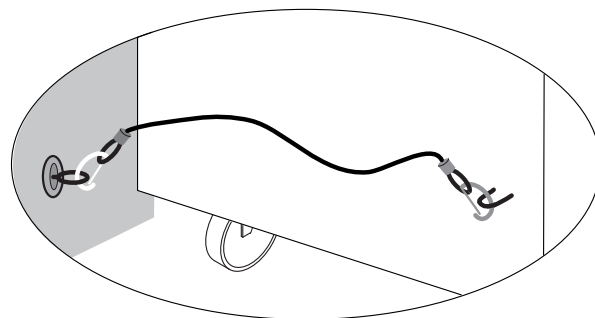

INSTALLATION

ELECTRICAL

1. An identification tag is permanently mounted on the cabinet.
2. Plug cabinet into a properly grounded receptacle ONLY, positioning the unit so the power supply cord is easily accessible in case of an emergency.
Arcing will occur when connecting or disconnecting the unit unless all controls are in the "OFF" position.
3. If necessary, a proper receptacle or outlet configuration as required for this unit, must be installed by a licensed electrician in accordance with applicable, local electrical codes.

For 230V:

To prevent an electrical shock hazard between the appliance and other appliances or metal parts in close vicinity, an equalization-bonding stud is provided. An equalization bonding lead must be connected to this stud and the other appliances / metal parts to provide sufficient protection against potential difference. The terminal is marked with the following symbol. 

NOTE:

The appliance must be connected to an electrical circuit that is protected by an external GFCI outlet.

CAUTION

THIS SECTION IS PROVIDED FOR THE ASSISTANCE OF QUALIFIED SERVICE TECHNICIANS ONLY AND IS NOT INTENDED FOR USE BY UNTRAINED OR UNAUTHORIZED SERVICE PERSONNEL.



DANGER











ENSURE POWER SOURCE
MATCHES VOLTAGE STAMPED
ON APPLIANCE NAMEPLATE.

DANGER



To avoid electrical shock, this appliance **MUST** be adequately grounded in accordance with local electrical codes or, in the absence of local codes, with the current edition of the National Electrical Code ANSI/NFPA No. 70. In Canada, all electrical connections are to be made in according with CSA C22.1, Canadian Electrical Code Part 1 or local codes.

ELECTRICAL- 1200-S							ELECTRICAL - 1200-UP							
	VOLTAGE	PHASE	CYCLE/ HZ	AMPS	kW			VOLTAGE	PHASE	CYCLE/ HZ	AMPS	kW	CORD & PLUG	
120	at 120	1	60	8.3	1.0		NEMA 5-15P, 15A-125V PLUG	120	at 120	1	60	16.0 1.92		NEMA 5-20P, 20A-125V PLUG
208 - 240 1000W	208-240 (AGCY)	1	60	4.2	1.0		NEMA 6-15P, 15A-250V PLUG	208 - 240 2000W	208-240 (AGCY)	1	60	9.6 2.0		NEMA 6-15P, 15A-250V PLUG
	at 208	1	60	3.6	.75		(USA ONLY)		at 208	1	60	7.2 1.5		(USA ONLY)
	at 240	1	60	4.2	1.0		NO CORD NO PLUG		at 240	1	60	9.6 2.0		NO CORD NO PLUG
208 - 240 2000W	208-240 (AGCY)	1	60	8.4	2.0		NO CORD NO PLUG	208 - 240 4000W	208-240 (AGCY)	1	60	16.7 4.0		NO CORD NO PLUG
	at 208	1	60	7.2	1.5		NO CORD NO PLUG		at 208	1	60	14.4 3.0		NO CORD NO PLUG
	at 240	1	60	8.4	2.0		NO CORD NO PLUG		at 240	1	60	16.7 4.0		NO CORD NO PLUG
230	at 230 1000W	1	50	3.9	.90		CEE 7/7, 220-230V PLUG	230	at 230 2000W	1	50	8.0 1.85		CEE 7/7, 220-230V PLUG
	at 230 2000W	1	50	7.8	1.8		CEE 7/7, 220-230V PLUG		at 230 4000W	1	50	16.0 3.67		CEE 7/7, 220-230V PLUG

INSTALLATION

USER SAFETY INFORMATION

This appliance is intended for use in commercial establishments where all operators are familiar with the purpose, limitations, and associated hazards of this appliance. Operating instructions and warnings must be read and understood by all operators and users.

1. Unit must be connected to the appropriate power source.
2. Use hand protection when handling hot items.
3. Preheat the unit for 30 minutes before use.
4. Be certain only hot foods are placed into the unit.

CAUTION



METAL PARTS OF THIS EQUIPMENT BECOME EXTREMELY HOT WHEN IN OPERATION. TO AVOID BURNS, ALWAYS USE HAND PROTECTION WHEN OPERATING THIS APPLIANCE.

BEFORE INITIAL USE:

1. Clean both the interior and exterior of the unit with a damp, clean cloth and mild soap solution. Rinse carefully.
2. Clean and install the cabinet side racks. Shelves should be positioned with the curved end up and toward the back of the unit (reach-in models).

HEATING CHARACTERISTICS

The cabinet is equipped with a special heating cable. Through this Halo Heat concept, the heating cable is mounted against the walls of the unit to provide an evenly applied heat source controlled by a thermostat. The design and operational characteristics of the unit eliminate the need for a moisture pan or a heat circulating fan. Through even heat application, the quality of food products is maintained up to several hours or more.



OPERATION

MANUAL CONTROL

1. PREHEAT AT 200°F (93°C) FOR 30 MINUTES BEFORE LOADING FOOD.

Push power switch to “ON” position. The power button will illuminate.

2. Rotate the control knob to 200°F (93°C). The *Set* temperature will appear in the Digital Display **5200** and the temperature display light will illuminate. Press the Temperature Display Button at any time to display the *Actual* inside air temperature **A190**.

To toggle between *Set* and *Actual*:

Factory default is to display *Set* temperature in the Digital Display. To display *Actual* temperature:

With the control ON press and hold the Temperature Button for 5 seconds. The control will show **ACT**, then show the *Actual* temperature.

Repeat to toggle to *Set* point **SET**.

Press the Temperature Display Button at any time to display the alternate temperature.

3. When the inside air temperature reaches the desired holding temperature, the temperature display light will turn off.

4. Load the cabinet with hot food only.

The purpose of the holding cabinet is to maintain hot food at proper serving temperatures. Only hot food should be placed into the cabinet. Before loading the unit with food, use a food thermometer to make certain all food products are at an internal temperature range of 140° to 160°F (60° to 71°C). All food not within the proper temperature range should be heated before loading into the holding cabinet.

5. Check to make certain the cabinet door is securely closed, and rotate the control knob to 160°F (71°C).

THIS WILL NOT NECESSARILY BE THE FINAL SETTING.

The proper temperature range for the food being held will depend on the type and quantity of product. Whether or not the door vents should be open or closed will also depend on the type of food being held. When holding food for prolonged periods, it is advisable to periodically check the internal temperature of each item to assure maintenance of the proper temperature range. Reset the holding temperature accordingly.

TO TOGGLE BETWEEN FAHRENHEIT AND CELSIUS

The factory default is Fahrenheit. To change to Celsius:

1. With the control OFF (i.e. temperature setting in the OFF position), press and hold the Temperature Display button for 5 seconds.
2. The control will show **DEGC** for 3 seconds to verify selection and then show the temperature. (Set Point or Actual, whichever the user has selected) in °C.
3. Repeat to toggle to Fahrenheit.

Note: With a power failure, factory test, etc., the control will retain the °C or °F setting selected by the user when power is restored.

POWER FAILURE

When power is lost, then resumes, the display will flash **-AC-** for 4 seconds, then display the set holding temperature for 4 seconds and will alternate until acknowledged. To acknowledge, press any key.

This feature will alert you when there is a power failure, indicating that **food safety may be compromised**.

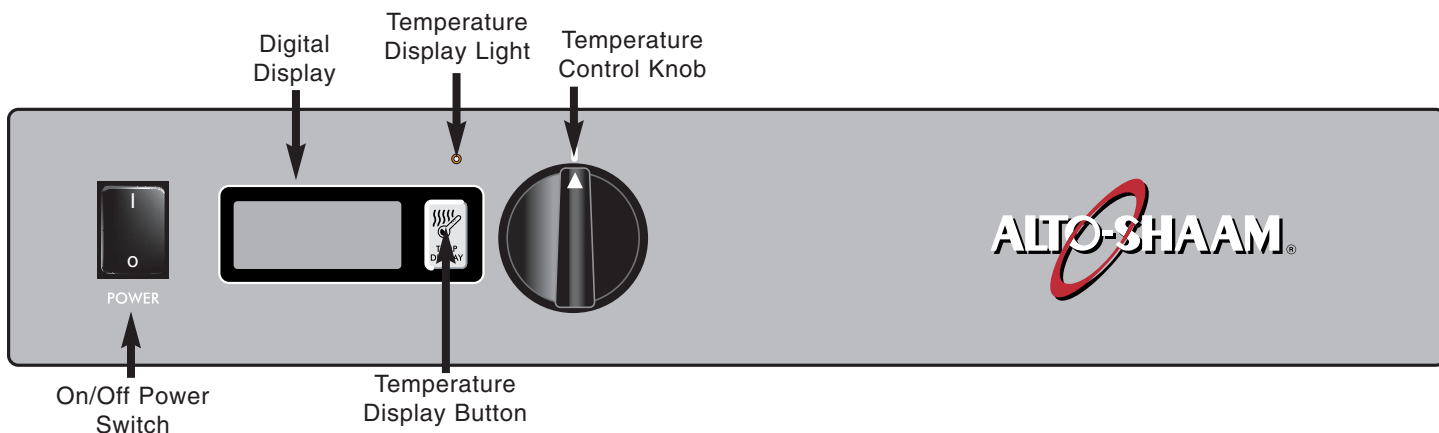

OPERATION

ELECTRONIC CONTROL OPTION

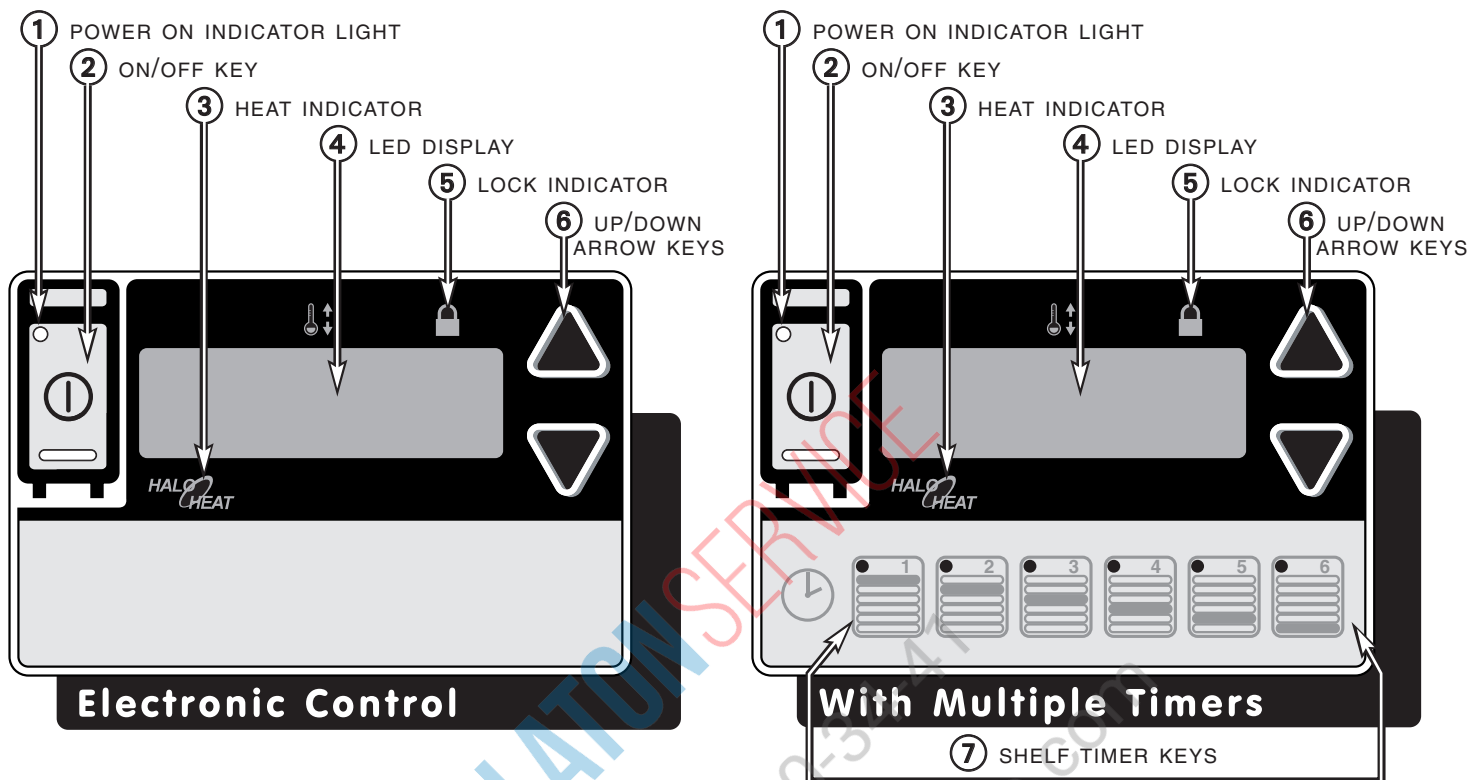

OPERATION

ELECTRONIC CONTROL SET-UP

ON/OFF KEY



Press the ON/OFF key once and the power indicator light will illuminate. Press and hold the ON/OFF key until the LED display turns off (at least three seconds) and power indicator light goes out.

UP/DOWN ARROW KEY



The UP and DOWN arrow keys are used for a variety of settings when selecting the holding temperature. If an arrow key is pressed and released the display will show the current set temperature for two seconds. If an arrow key is held (at least eight seconds), the value will change at a rapid rate. If the arrow key is pressed and released in rapid succession, the set temperature will change by increments of one degree.



ENABLE / DISABLE BEEPER



A beeper sounds when an error code is displayed. To choose between beeper on and beeper off mode, the control must be off, then press and hold the DOWN arrow key until either "ON" or "OFF" is shown in the LED display. Release arrow key when desired mode is displayed.

FAHRENHEIT/CELSIUS



With the control off, to choose between Fahrenheit and Celsius, press and hold the UP arrow key until either °F or °C is shown in LED display. Release key when desired setting is displayed.

The control has a four-digit LED display. When the display is on, it will show current holding temperature, as well as diagnostic information.

CONTROL LOCK

The warmer controls can be locked so that no changes can be made to the set temperature.

To lock the display, press and hold the ON/OFF key and the Up Arrow key at the same time. The lock LED will illuminate. When the lock LED is illuminated, additional programming will not be functional other than the key sequence required to unlock the panel. To unlock the display, press and hold the ON/OFF key and the Down Arrow key at the same time. The lock LED will extinguish. The panel keys will resume normal function.

ELECTRONIC CONTROL OPERATION

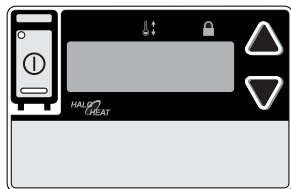

1. Preheat at 200°F (93°C) for 30 minutes.

Press the ON key, and set the temperature to 200°F (93°) by using the UP/DOWN arrow keys. Allow a minimum of 30

minutes preheating time before loading the holding cabinet with food. Closing the vents on the inside of the door will speed the preheating process. The LED heat indicator light will go "Out" after approximately 30 minutes preheat time, or when the air temperature inside the unit reaches the temperature set by the operator. The Set indicator will light up anytime the temperature is set or reset.

2. Load with hot food only.

The purpose of the holding cabinet is to maintain hot food at proper serving temperature. Only hot food should be placed into the cabinet. Before loading the cabinet with food, use a food

thermometer to make certain all products are at an internal temperature range of 140° to 160°F (60° to 71°C). Any food product not within the proper temperature range should be heated before loading into the holding cabinet.

3. Reset the control to 160°F (71°C).

Check to make certain the cabinet door is securely closed, and reset to 160°F (71°C) by using the UP/DOWN keys

THIS WILL NOT NECESSARILY BE THE FINAL SETTING.

The proper temperature range and OPEN or CLOSED door vent position will depend on the type and quantity of product. When holding food for prolonged periods, it is advisable to periodically check the internal temperature of each item with a food thermometer to assure maintenance of the proper temperature range of 140° to 160°F (60° to 71°C).

OPERATION

ELECTRONIC HOLDING CABINET SPECIAL FEATURES

HEAT RECOVERY

The patented SureTemp™ heat recovery system in this unit will immediately compensate for any loss of heat when the door is opened. In order to maintain a more consistent cavity temperature, the control will automatically apply heat to the unit's interior while the door is open and for a short time after the door is closed. If the door remains open for more than three minutes, the solid state electronic control will sound three rapid beeps every ten seconds until the door is closed.

HACCP DOCUMENTATION OPTION

Web-based documentation software provides both a simple and effective method of temperature recording. The system is designed to interface with Alto-Shaam electronic cook/hold ovens, hot food holding cabinets, Combitherm® combi oven/steamers, and Quickchillers™. All relevant information is recorded and stored, and is accessible from the convenience of one or more computer stations. Stored information is displayed in a detailed overview for evaluation and printing as required.

- Records cooking and holding time and temperature
- Pass/fail summary for review or printing
- Automatic data storage accessible in a variety of formats
- Supports up to 16 appliance addresses on one network

HACCP DOCUMENTATION WITH KITCHEN MANAGEMENT OPTION

Web-based software incorporates the latest technology providing the ability to program, control, monitor, and store all relevant cooking and hot food holding data through the Internet from a single site or multiple sites. Automated sampling, record keeping, and set-point validation meet the requirements of established HACCP criteria. Designed to help manage the fully integrated food service facility.

- HACCP compliant automated logging/database storage
- Printed HACCP reports
- Data analysis for corrective action
- "Real time" sensor values and alarms
- Alarm notification via e-mail, pager, mobile phone
- Supports up to 16 appliance addresses on one network

For more information refer to HACCP Spec Sheet #9015.



DOUGH PROOFING INSTRUCTIONS

MANUAL AND ELECTRONIC CABINETS

With the addition of a pan of water, warming cabinets can be used for proofing dough. A water reservoir pan (#1775) and pan cover (#1774) is available as an option from Alto-Shaam.

1. Remove dough from retarder or refrigerator and allow covered product to set up at room temperature.
2. Set holding thermostat temperature to 95°F (35°C).
3. Pour approximately 2 quarts (c. 2 liters) of hot water into the optional water reservoir pan and place the pan on the bottom surface of the compartment. The temperature of the water should be 140° to 180°F (60° to 82°C).
4. Allow the cabinet to preheat for 45 to 60 minutes.
5. Remove covering and place dough in preheated cabinet.
6. Allow dough to remain in the cabinet until it nearly doubles in size.
7. Remove product from cabinet and bake according to product manufacturer's directions. Brush with eggwash if desired.

NOTE: The above proofing procedure is a suggested guideline only. Due to variation from product to product, including quality and product weight, close adherence the product manufacturer's instructions is strongly recommended.

OPERATION

ELECTRONIC CONTROL TIMER PROGRAMMING

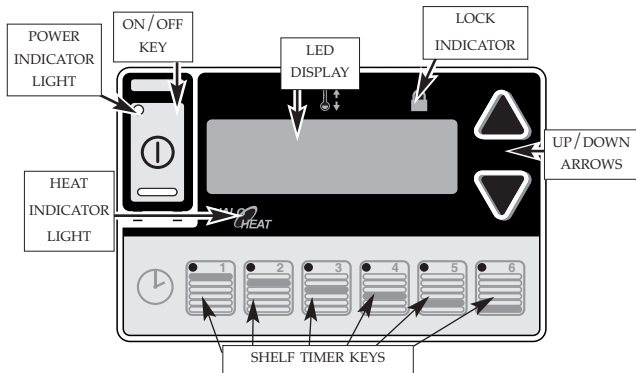

The Multiple Shelf Timer Key option is available for hot food holding units with the electronic control. These keys monitor food safety by using a timer-based "First-In, First-Out" product management system. Products should be cooked to HACCP recommended internal temperature and then held in the unit. The Timer system allows operator to select holding times when the unit is loaded. Multiple timer keys correspond to various pan locations in the holding unit. As the timers expire, alarms notify the operator.

Timer Programming Information

1. Turn On/Off Control Key OFF.



Press the On/Off Key until the display turns OFF (at least 3 seconds) and On/Off Key's Power Indicator Light goes out.

Note: The following steps can only be done when the On/Off Control Key is OFF.

2. Set Shelf Timer Keys.



Press and hold a Shelf Timer Key (at least 3 seconds) until the countdown time is shown in the LED display. Use the Up or Down Arrow Key to change the time desired.

▲ Time will display as HH:MM if set for longer than 60 minutes, or HH:SS if set for less than 60 minutes.
▼

3. Set Additional Timer Keys.



Repeat step 2 for each Shelf Timer Key to be programmed.

4. Turn On/Off Power Key ON.



Using the timer, press the On/Off key to turn ON unit. Power Indicator Light will illuminate.

5. Press Shelf Timer Key.



Activate the shelf timer by pressing the corresponding button. Shelf LED display will illuminate and the count down will begin.

The timer LED's will illuminate as follows:

- All expired timers will flash quickly (may be more than one)
- The timer with the shortest amount of time remaining will flash slowly.
- All other active timers will be illuminated (may be more than one).

6. Turn OFF alarm.

Alarm will sound as time expires.



Press expired Shelf Timer Key to turn the alarm OFF.

To Cancel a Timer:

Press and hold desired Shelf Timer Key for two seconds.

Power Failure:

The Power Indicator Light by On/Off Power Key will blink to indicate a power failure. To stop the blinking, simply depress On/Off Key. The memory will not be impaired.

OPERATION

GENERAL HOLDING GUIDELINES

Chefs, cooks and other specialized food service personnel employ varied methods of cooking. Proper holding temperatures for a specific food product must be based on the moisture content of the product, product density, volume, and proper serving temperatures. Safe holding temperatures must also be correlated with palatability in determining the length of holding time for a specific product.

Halo Heat maintains the maximum amount of product moisture content without the addition of water, water vapor, or steam. Maintaining maximum natural product moisture preserves the natural flavor of the product and provides a more genuine taste. In addition to product moisture retention, the gentle properties of Halo Heat maintain a consistent temperature throughout the cabinet without the necessity of a heat distribution fan, thereby preventing further moisture loss due to evaporation or dehydration.

In an enclosed holding environment, too much moisture content is a condition which can be relieved. A product achieving extremely high temperatures in preparation must be allowed to decrease in temperature before being placed in a controlled holding atmosphere. If the product is not allowed to decrease in temperature, excessive condensation will form increasing the moisture content on the outside of the product. To preserve the safety and quality of freshly cooked foods however, a maximum of 1 to 2 minutes must be the only time period allowed for the initial heat to be released from the product.

Most Halo Heat holding equipment is provided with a thermostat control between 60° and 200°F (16° to 93°C). If the unit is equipped with vents, close the vents for moist holding and open the vents for crisp holding.

If the unit is equipped with a thermostat indicating a range of between 1 and 10, use a metal-stemmed indicating thermometer to measure the internal temperature of the product(s) being held. Adjust the thermostat setting to achieve the best overall setting based on internal product temperature.

HOLDING TEMPERATURE RANGE		
MEAT	FAHRENHEIT	CELSIUS
BEEF ROAST — Rare	130°F	54°C
BEEF ROAST — Med/Well Done	155°F	68°C
BEEF BRISKET	160° — 175°F	71° — 79°C
CORN BEEF	160° — 175°F	71° — 79°C
PASTRAMI	160° — 175°F	71° — 79°C
PRIME RIB — Rare	130°F	54°C
STEAKS — Broiled/Fried	140° — 160°F	60° — 71°C
RIBS — Beef or Pork	160°F	71°C
VEAL	160° — 175°F	71° — 79°C
HAM	160° — 175°F	71° — 79°C
PORK	160° — 175°F	71° — 79°C
LAMB	160° — 175°F	71° — 79°C
POULTRY		
CHICKEN — Fried/Baked	160° — 175°F	71° — 79°C
DUCK	160° — 175°F	71° — 79°C
TURKEY	160° — 175°F	71° — 79°C
GENERAL	160° — 175°F	71° — 79°C
FISH/SEAFOOD		
FISH — Baked/Fried	160° — 175°F	71° — 79°C
LOBSTER	160° — 175°F	71° — 79°C
SHRIMP — Fried	160° — 175°F	71° — 79°C
BAKED GOODS		
BREADS/ROLLS	120° — 140°F	49° — 60°C
MISCELLANEOUS		
CASSEROLES	160° — 175°F	71° — 79°C
DOUGH — Proofing	80° — 100°F	27° — 38°C
EGGS — Fried	150° — 160°F	66° — 71°C
FROZEN ENTREES	160° — 175°F	71° — 79°C
HORS D'OEUVRES	160° — 180°F	71° — 82°C
PASTA	160° — 180°F	71° — 82°C
PIZZA	160° — 180°F	71° — 82°C
POTATOES	180°F	82°C
PLATED MEALS	140° — 165°F	60° — 74°C
SAUCES	140° — 200°F	60° — 93°C
SOUP	140° — 200°F	60° — 93°C
VEGETABLES	160° — 175°F	71° — 79°C
THE HOLDING TEMPERATURES LISTED ARE SUGGESTED GUIDELINES ONLY. ALL FOOD HOLDING SHOULD BE BASED ON INTERNAL PRODUCT TEMPERATURES. ALWAYS FOLLOW LOCAL HEALTH (HYGIENE) REGULATIONS FOR ALL INTERNAL TEMPERATURE REQUIREMENTS.		

CARE AND CLEANING

CLEANING AND PREVENTIVE MAINTENANCE

PROTECTING STAINLESS STEEL SURFACES



It is important to guard against corrosion in the care of stainless steel surfaces. Harsh, corrosive, or inappropriate chemicals can completely destroy the

protective surface layer of stainless steel. Abrasive pads, steel wool, or metal implements will abrade surfaces causing damage to this protective coating and will eventually result in areas of corrosion. Even water, particularly hard water that contains high to moderate concentrations of chloride, will cause oxidation and pitting that result in rust and corrosion. In addition, many acidic foods spilled and left to remain on metal surfaces are contributing factors that will corrode surfaces.

Proper cleaning agents, materials, and methods are vital to maintaining the appearance and life of this appliance. Spilled foods should be removed and the area wiped as soon as possible but at the very least, a minimum of once a day. Always thoroughly rinse surfaces after using a cleaning agent and wipe standing water as quickly as possible after rinsing.

CLEANING AGENTS

Use non-abrasive cleaning products designed for use on stainless steel surfaces. Cleaning agents must be chloride-free compounds and must not contain quaternary salts. Never use hydrochloric acid (muriatic acid) on stainless steel surfaces. Always use the proper cleaning agent at the manufacturer's recommended strength. Contact your local cleaning supplier for product recommendations.

CLEANING MATERIALS

The cleaning function can usually be accomplished with the proper cleaning agent and a soft, clean cloth. When more aggressive methods must be employed, use a non-abrasive scouring pad on difficult areas and make certain to scrub with the visible grain of surface metal to avoid surface scratches. Never use wire brushes, metal scouring pads, or scrapers to remove food residue.

 CAUTION	
 NO SCRAPERS	TO PROTECT STAINLESS STEEL SURFACES, COMPLETELY AVOID THE USE OF ABRASIVE CLEANING COMPOUNDS, CHLORIDE BASED CLEANERS, OR CLEANERS CONTAINING QUATERNARY SALTS. NEVER USE HYDROCHLORIC ACID (MURIATIC ACID) ON STAINLESS STEEL. NEVER USE WIRE BRUSHES, METAL SCOURING PADS OR SCRAPERS.
 NO WIRE BRUSHES	
 NO STEEL PADS	

CARE AND CLEANING



The cleanliness and appearance of this equipment will contribute considerably to operating efficiency and savory, appetizing food. Good equipment that is kept clean works better and lasts longer.

CLEAN THE HOLDING CABINET DAILY:

1. Disconnect unit from power source, and let cool.
2. Remove all detachable items such as shelves, side racks, and drip pan. Clean these items separately with a good grease solvent or commercial detergent. Rinse well and dry.
3. Clean interior metal surfaces of the unit with a damp, clean cloth and any good commercial detergent or grease solvent at the recommended strength. Spray heavily soiled areas with a water soluble degreaser and let stand for 10 minutes, then remove soil with a plastic scouring pad. Rinse by wiping with a sponge and clean warm water to remove all residue. Remove excess water with sponge and wipe dry with a clean cloth or air dry. Replace side racks and shelves.
4. Clean control panel, door vents, door handles, and door gaskets thoroughly since these areas harbor food debris. Rinse by wiping with sponge and clean warm water. Wipe dry with a clean cloth.
5. Interior can be wiped with a sanitizing solution after cleaning and rinsing. This solution must be approved for use on stainless steel food contact surfaces.
6. To help maintain the protective film coating on polished stainless steel, clean the exterior of the unit with a cleaner recommended for stainless steel surfaces. Spray the cleaning agent on a clean cloth and wipe with the grain of the stainless steel.



Always follow appropriate state or local health (hygiene) regulations regarding all applicable cleaning and sanitation requirements for foodservice equipment.

NOTE: Avoid the use of abrasive cleaning, compounds, chloride based cleaners, or cleaners containing quaternary salts. Never use hydrochloric acid (muriatic acid) on stainless steel.

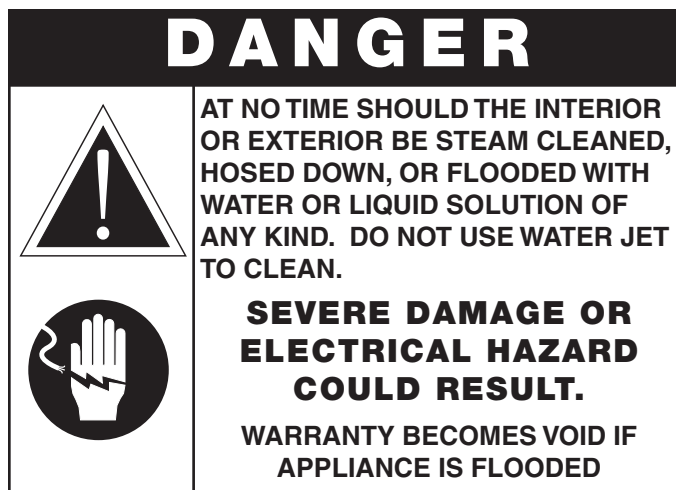
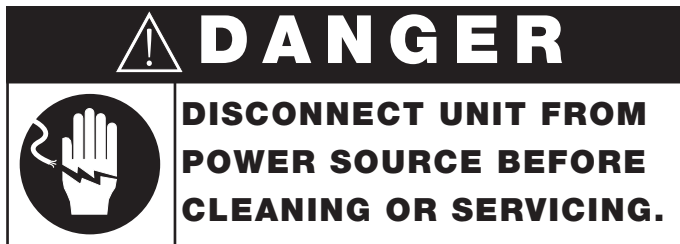

SANITATION

Food flavor and aroma are usually so closely related that it is difficult, if not impossible, to separate them. There is also an important, inseparable relationship between cleanliness and food flavor. Cleanliness, top operating efficiency, and appearance of equipment contribute considerably to savory, appetizing foods. Good equipment that is kept clean, works better and lasts longer.

Most food imparts its own particular aroma and many foods also absorb existing odors. Unfortunately, during this absorption, there is no distinction between GOOD and BAD odors. The majority of objectionable flavors and odors troubling food service operations are caused by bacteria growth. Sourness, rancidity, mustiness, stale or other OFF flavors are usually the result of germ activity.

The easiest way to insure full, natural food flavor is through comprehensive cleanliness. This means good control of both visible soil (dirt) and invisible soil (germs). A thorough approach to sanitation will provide essential cleanliness. It will assure an attractive appearance of equipment, along with maximum efficiency and utility. More importantly, a good sanitation program provides one of the key elements in the prevention of food-borne illnesses.

A controlled holding environment for prepared foods is just one of the important factors involved in the prevention of food-borne illnesses. Temperature monitoring and control during receiving, storage, preparation, and the service of foods are of equal importance.

The most accurate method of measuring safe temperatures of both hot and cold foods is by internal product temperature. A quality thermometer is an effective tool for this purpose, and should be routinely used on all products that require holding at a specific temperature.

A comprehensive sanitation program should focus on the training of staff in basic sanitation procedures. This includes personal hygiene, proper handling of raw foods, cooking to a safe internal product temperature, and the routine monitoring of internal temperatures from receiving through service.

Most food-borne illnesses can be prevented through proper temperature control and a comprehensive program of sanitation. Both these factors are important to build quality service as the foundation of customer satisfaction. Safe food handling practices to prevent food-borne illness is of critical importance to the health and safety of your customers.

HACCP, an acronym for Hazard Analysis (at) Critical Control Points, is a quality control program of operating procedures to assure food integrity, quality, and safety. Taking steps necessary to augment food safety practices are both cost effective and relatively simple. While HACCP guidelines go far beyond the scope of this manual, additional information is available by contacting:

**CENTER FOR FOOD SAFETY AND APPLIED
NUTRITION FOOD AND DRUG ADMINISTRATION
1-888-SAFEFOOD**

INTERNAL FOOD PRODUCT TEMPERATURES		
HOT FOODS		
DANGER ZONE	40° TO 140°F	(4° TO 60°C)
CRITICAL ZONE	70° TO 120°F	(21° TO 49°C)
SAFE ZONE	140° TO 165°F	(60° TO 74°C)
COLD FOODS		
DANGER ZONE	ABOVE 40°F	(ABOVE 4°C)
SAFE ZONE	36°F TO 40°F	(2°C TO 4°C)
FROZEN FOODS		
DANGER ZONE	ABOVE 32°F	(ABOVE 0°C)
CRITICAL ZONE	0° TO 32°F	(-18° TO 0°C)
SAFE ZONE	0°F or below	(-18°C or below)

SERVICE

THERMOSTAT ACCURACY

The electronic thermostat is a precise instrument and is designed to offer trouble free service. If you suspect the temperature inside the holding compartment does not match the temperature indicated on the digital display, follow the instructions listed below.

1. Check to make certain the unit voltage matches the power source. A power source less than that required to operate the unit will result in inaccurate temperatures.
2. Verify the temperature inside the holding compartment with a qualify thermal indicator.
 - A. With the exception of the wire shelves, completely empty the holding compartment.
 - B. Make certain the holding cabinet sensor, located inside the holding compartment at the left side of the unit, is completely clean.
 - C. Suspend the thermal indicator in the center of the holding compartment.
 - D. Allow the temperature set on the electronic thermostat to stabilize for a minimum of one hour before comparing the digital display with the reading on the thermal indicator.

DO NOT OPEN THE CABINET DOOR(S)
DURING THE TEMPERATURE
STABILIZATION PERIOD.

If the reading on the thermal indicator does not match the digital display, there may be a problem with the air sensor. See troubleshooting guide in this manual; or call the factory service department for advice.

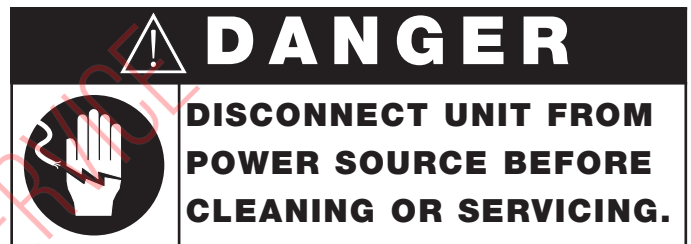

SERVICE

TROUBLESHOOTING - MANUAL CONTROL

Error Code	Description/Results	Possible Cause Service Required
E-10	Air Sensor Fault (shorted) <i>Inoperative Unit</i>	Air sensor is shorted. Air sensor defective? Test air sensor by placing sensor in ice water bath 32°F (0°C) and using an ohmmeter set on the ohm scale. The reading should be 100 ohms resistance. If it is more than 2 ohms higher or lower, sensor needs to be replaced. If Ohm reading is 100, replace display. If Ohm reading is not 100, replace sensor.
E-11	Air Sensor Fault (open) <i>Inoperative Unit</i>	Air sensor is open or connection failure. Air sensor defective? See above for air sensor test.
E-30	Under temperature <i>Oven will not reach set temperature</i>	Unit door closed? Door gasket need replacement? Preheat skipped? Unit overloaded or holding frozen product? Defective air sensor or probe? Defective solid state relay? Bad wire connections or open heating cable? If none of the above, contact Alto-Shaam Service Department.
E-31	Over temperature <i>Unit will shut down</i>	Unit has exceeded its maximum allowable set temperature by 25 degrees for at least 3 minutes. Unit will shut down. Defective sensor or poor sensor connection? Defective relay? Shorted heater element? If none of the above, contact Alto-Shaam Service Department.
E-70	Configuration error <i>Inoperative Unit</i>	Contact Alto-Shaam Service Department for correct DIP-switch settings.
E-82 or E-83	EEPROM Error - Bad Checksum <i>Inoperative Unit</i>	Contact Alto-Shaam Service Department for help resetting the control.
E-90	Button shorted <i>Inoperative Control</i>	Stuck button on control panel. Check buttons. If control is still inoperative, contact Alto-Shaam Service Department.
E-91	Input failure	Contact Alto-Shaam Service Department.
-AC-	Power Failure	Press any key to acknowledge.

This section is provided for the assistance of qualified technicians only and is not intended for use by untrained or unauthorized service personnel. If your Alto-Shaam® unit is not operating properly, check the following before calling your Authorized Alto-Shaam® Service Agent:

- ☛ Check the power flow to the unit. Plug in outlet? Circuit breaker switch at back of unit turned on?
Do not attempt to repair or service the holding cabinet beyond this point. Contact Alto-Shaam® for the nearest authorized service agent. Repairs made by any other service agents without prior authorization by Alto-Shaam® will void the warranty on the unit.



DANGER



**DISCONNECT UNIT FROM
POWER SOURCE BEFORE
CLEANING OR SERVICING.**

CAUTION

**THIS SECTION IS PROVIDED FOR THE ASSISTANCE
OF QUALIFIED SERVICE TECHNICIANS ONLY AND
IS NOT INTENDED FOR USE BY UNTRAINED OR
UNAUTHORIZED SERVICE PERSONNEL.**

SERVICE

This section is provided for the assistance of qualified technicians only and is not intended for use by untrained or unauthorized service personnel. If your Alto-Shaam® unit is not operating properly, check the following before calling your Authorized Alto-Shaam® Service Agent:

- Check the power flow to the unit. Plug in outlet? Circuit breaker switch at back of unit turned on?
Do not attempt to repair or service the holding cabinet beyond this point. Contact Alto-Shaam® for the nearest authorized service agent. Repairs made by any other service agents without prior authorization by Alto-Shaam® will void the warranty on the unit.

TROUBLE SHOOTING - ELECTRONIC CONTROL

TROUBLE	POSSIBLE CAUSE
Control will not turn on.	The unit is not connected to a power source (plugged in). The main power switch is in the off position. Insufficient voltage
Control operates but cannot control temperature.	Defective air sensor or poor sensor connection. Control is not calibrated. Defective heating element or damaged heating element connection.
Control operates but unit does not heat.	Defective air sensor or poor sensor connection. Control is not calibrated. Open heating element or poor heating element connection.



DANGER



DISCONNECT UNIT FROM POWER SOURCE BEFORE CLEANING OR SERVICING.

CAUTION

THIS SECTION IS PROVIDED FOR THE ASSISTANCE OF QUALIFIED SERVICE TECHNICIANS ONLY AND IS NOT INTENDED FOR USE BY UNTRAINED OR UNAUTHORIZED SERVICE PERSONNEL.



SERVICE

1200-S - MANUAL CONTROL



ITEM	PART NO.	DESCRIPTION	QTY	ITEM	PART NO.	DESCRIPTION	QTY
1	5008316	BONNET ASSEMBLY, MANUAL	1		PE-28366	CONTROL PANEL OVERLAY, ELEC	1
	5007801	BONNET ASSEMBLY, ELECTRONIC	1	8	55018	DOOR ASSEMBY	1
2	1010525	BOTTOM	1		5005142	DOOR ASSEMBLY WITH WINDOW	1
3	16042	CASING, BACK, HEAVY DUTY	1	9	HD-27080	DOOR HANDLE	1
	16057	CASING, BACK, STANDARD	1	10	HG-2015	DOOR HINGE, EACH	2
4	16041	CASING, SIDE, HEAVY DUTY	2	11	GS-23796	DOOR GASKET, EACH	1
	16056	CASING, SIDE, STANDARD	2	12	IN-22364	INSULATION (NOT SHOWN)	1
5	4007	CASTER PACKAGE, 5" (127MM)	1	13	16046	SIDE RAIL, EACH	2
6	PE-28280	CONTROL PANEL BEZEL	1	14	SR-24762	UNIVERSAL PAN SLIDE, EACH, S/S	2
7	PE-28451	CONTROL PANEL OVERLAY, MANUAL	1		SR-24447	UNIVERSAL PAN SLIDE, EA, CHROME	2

SERVICE

1200-UP - MANUAL CONTROL



SERVICE

SERVICE PARTS LIST - EXTERIOR

DESCRIPTION	1200-S	1200-UP
1. Bonnet Assembly, Spot MANUAL CONTROL ELECTRONIC CONTROL	5008316 5007801	5008316 5007801
2. Bottom (NOT SHOWN)	1010525	1010525
3. Casing, Back (NOT SHOWN) HEAVY DUTY STANDARD	16042 16057	16032 16054
4. Casing, Side HEAVY DUTY STANDARD	16041 16056	16033 16055
5. Caster Package, 5" (127mm), 2 RIGID, 2 SWIVEL w/ BRAKE	4007	4007
6. Control Panel Bezel	PE-28280	PE-28280
7. Control Panel Overlay MANUAL CONTROL ELECTRONIC CONTROL	PE-28451 PE-28366	PE-28367 PE-27855
8. Door Assembly	55018	55018
9. Door Assembly with Window	5005142	5005142
10. Door Handle	HD-27080	HD-27080
11. Door Hinge, each	HG-2015	HG-2015
12. Door Gasket, each	GS-23796	GS-23796
13. Insulation (NOT SHOWN)	IN-22364	IN-22364
14. Side Rail for pan slide, ea.	16046	16046
15. Universal Pan Slide, ea. STAINLESS STEEL, 230V CHROME PLATED	SR-24762 SR-24447	SR-24762 SR-24447

CABLE HEATING SERVICE KIT (ONE KIT PER CABINET COMPARTMENT)

No. 4878 for all except 4000W cabinets

INCLUDES:

CB-3045	Cable Heating Element . . .85 feet (2591cm)
CR-3226	Ring Connector4
IN-3488	Insulation Corner1 foot (30,5cm)
BU-3105	Shoulder Bushing4
BU-3106	Cup Bushing4
ST-2439	Stud4
NU-2215	Hex Nut8
SL-3063	Insulating Sleeve4
TA-3540	Electrical Tape1 roll

No. 4881 for 4000W cabinets

INCLUDES:

CB-3045	Cable Heating Element . .210 feet (6401cm)
CR-3226	Ring Connector12
IN-3488	Insulation Corner1 foot (30,5cm)
BU-3105	Shoulder Bushing12
BU-3106	Cup Bushing12
ST-2439	Stud12
NU-2215	Hex Nut24
SL-3063	Insulating Sleeve12
TA-3540	Electrical Tape1 roll



DANGER



**DISCONNECT UNIT FROM
POWER SOURCE BEFORE
CLEANING OR SERVICING.**

CAUTION

**THIS SECTION IS PROVIDED FOR THE ASSISTANCE
OF QUALIFIED SERVICE TECHNICIANS ONLY AND
IS NOT INTENDED FOR USE BY UNTRAINED OR
UNAUTHORIZED SERVICE PERSONNEL.**

SERVICE

1200-UP with Manual Control - 120V Unit Shown

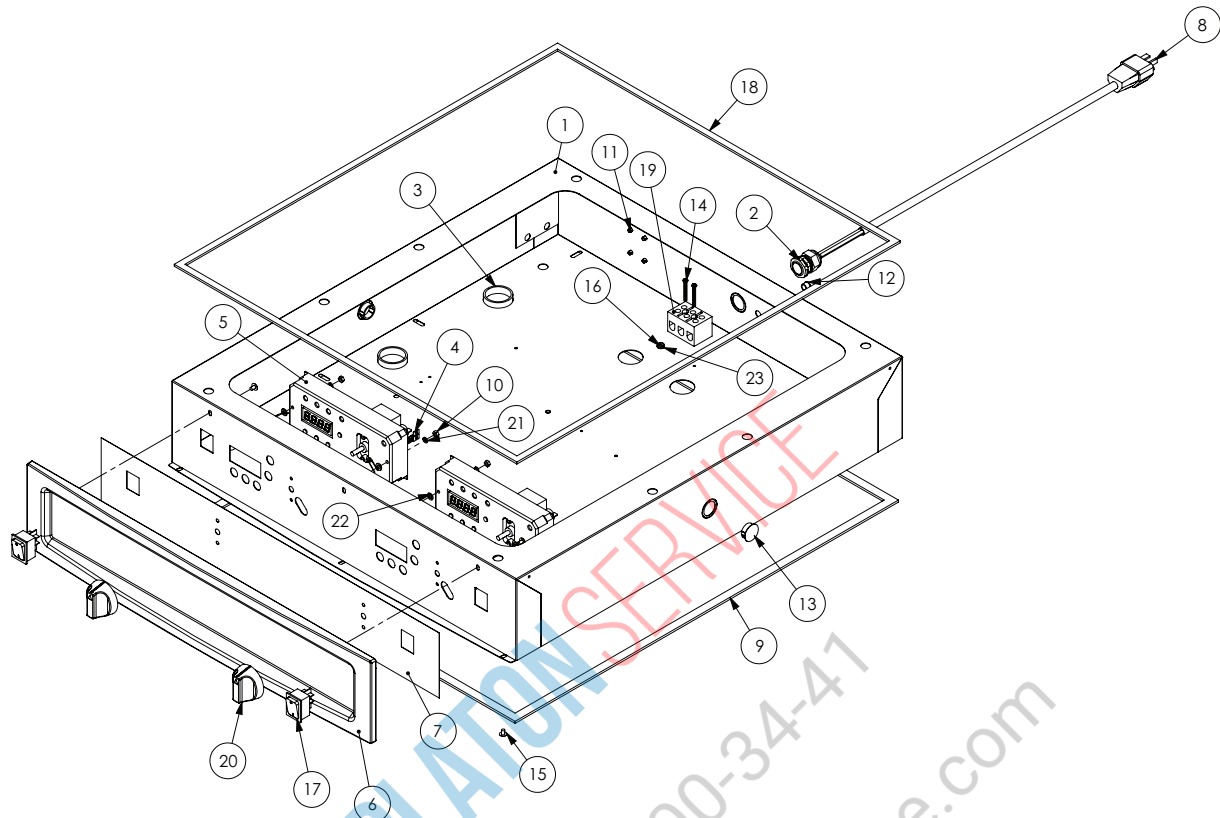

1200-UP with Manual Control - 208-240V Unit Shown

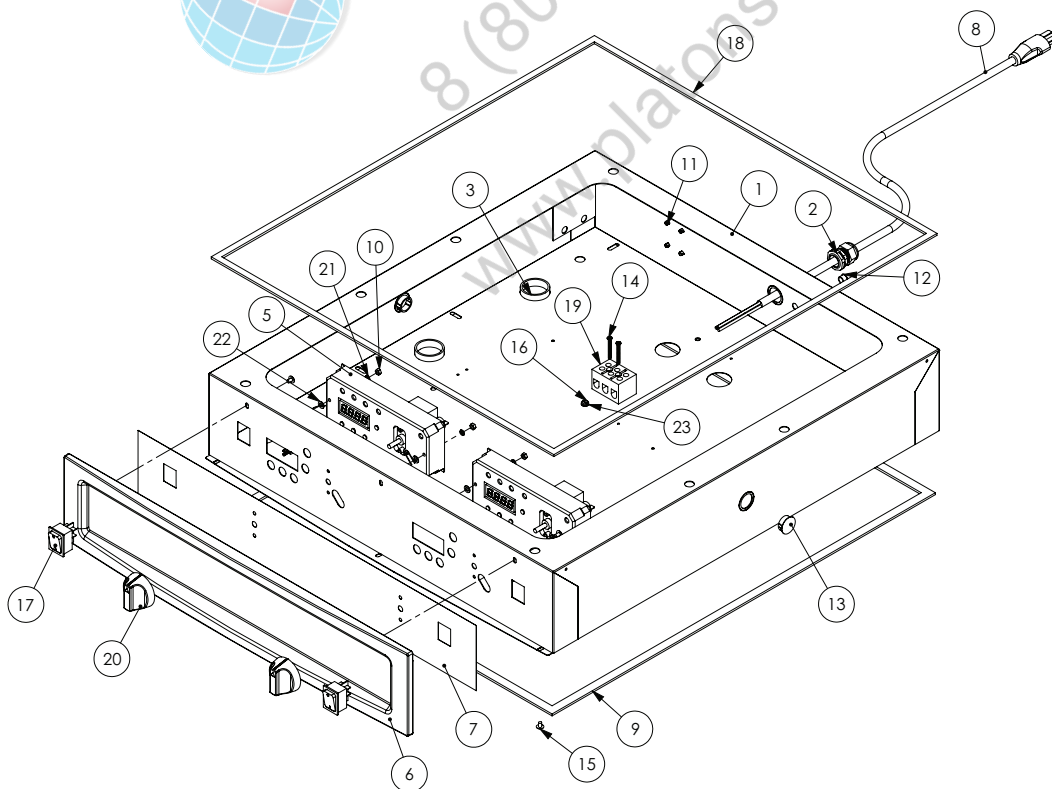

SERVICE

1200-UP with Manual Control - 230V Unit Shown

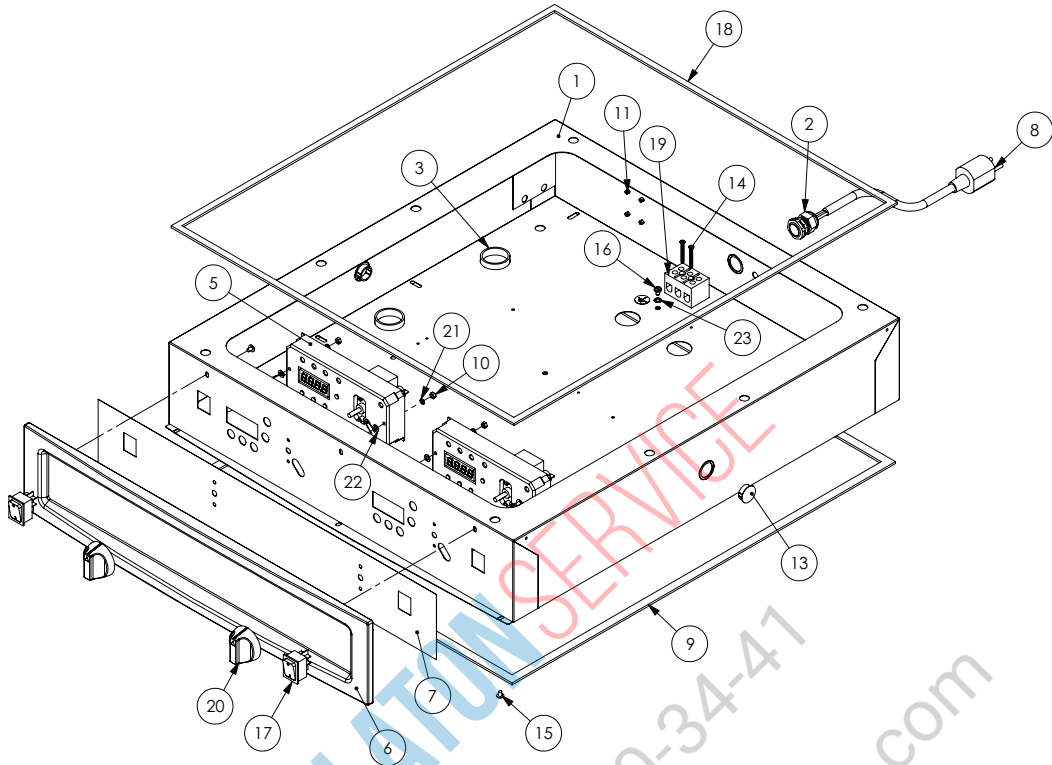

1200-S with Manual Control - 120V Unit Shown

1200-S 208-240V AND 230V
DRAWINGS NOT AVAILABLE AT THIS TIME

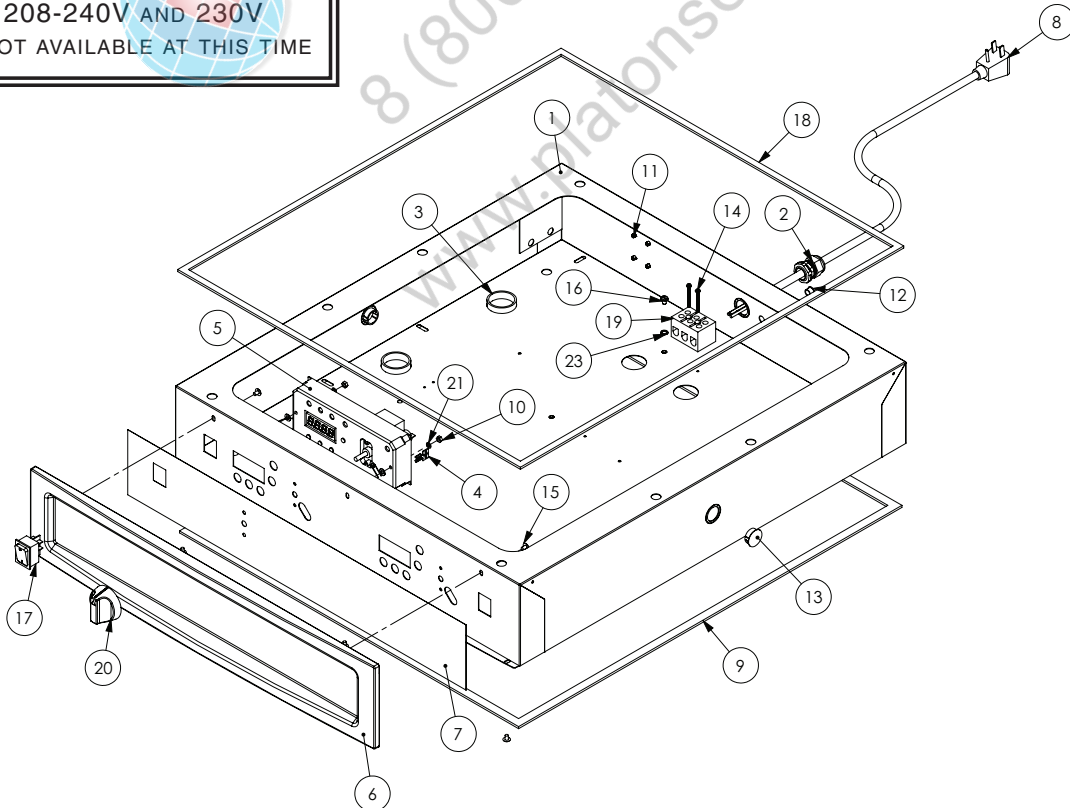

SERVICE

SERVICE PARTS LIST - MANUAL CONTROL

DESCRIPTION	1200-S	1200-UP
1. Bonnet Assembly, Spot	5008316	5008316
2. Bushing, Cord Strain Relief	BU-3964	BU-3964
3. Bushing, Snap, 1-1/2"	BU-3013	BU-3013
4. Connector	CR-34559	CR-34559
5. Control, Manual	CC-34488	CC-34488
6. Control Panel Bezel	PE-28280	PE-28280
7. Control Panel Overlay, Manual	PE-28451	PE-28367
8. Cordset, Manual		
	120V	CD-3232
	208-240V	CD-3551
	230V	CD-3922
9. Gasket, Self Adhesive	GS-2019	GS-2019
10. Nut, Hex, M4-0.7, 18-8	NU-22286	NU-22286
11. Plug, Dome, .187" hole	PG-28439	PG-28439
12. Plug, Hole 3/8"	PG-25574	PG-25574
13. Plug, Hole 13/16"	PG-3589	PG-3589
14. Screw, 6-32 x 1-1/4" Round Head	SC-2365	SC-2365
15. Screw, 8-32 x 1/4" Phil Screw	SC-2459	SC-2459
16. Screw, Ground, 10-32 x 1/4" Pan Head	SC-2190	SC-2190
17. Switch, Rocker	SW-34769	SW-34769
18. Tape, .375" wide foam	GS-23622	GS-23622
19. Terminal Block	BK-3019	BK-3019
20. Thermostat Knob, Manual	KN-26568	KN-26568
21. Washer, M4 Split Lock S/S 18-8	WS-22300	WS-22300
22. Washer, #10 Nylon	WS-2420	WS-2420
23. Washer, Star Lock	WS-2467	WS-2467



DANGER



**DISCONNECT UNIT FROM
POWER SOURCE BEFORE
CLEANING OR SERVICING.**

CAUTION

**THIS SECTION IS PROVIDED FOR THE ASSISTANCE
OF QUALIFIED SERVICE TECHNICIANS ONLY AND
IS NOT INTENDED FOR USE BY UNTRAINED OR
UNAUTHORIZED SERVICE PERSONNEL.**

SERVICE

1200-UP with Electronic Control - 230V Unit Shown

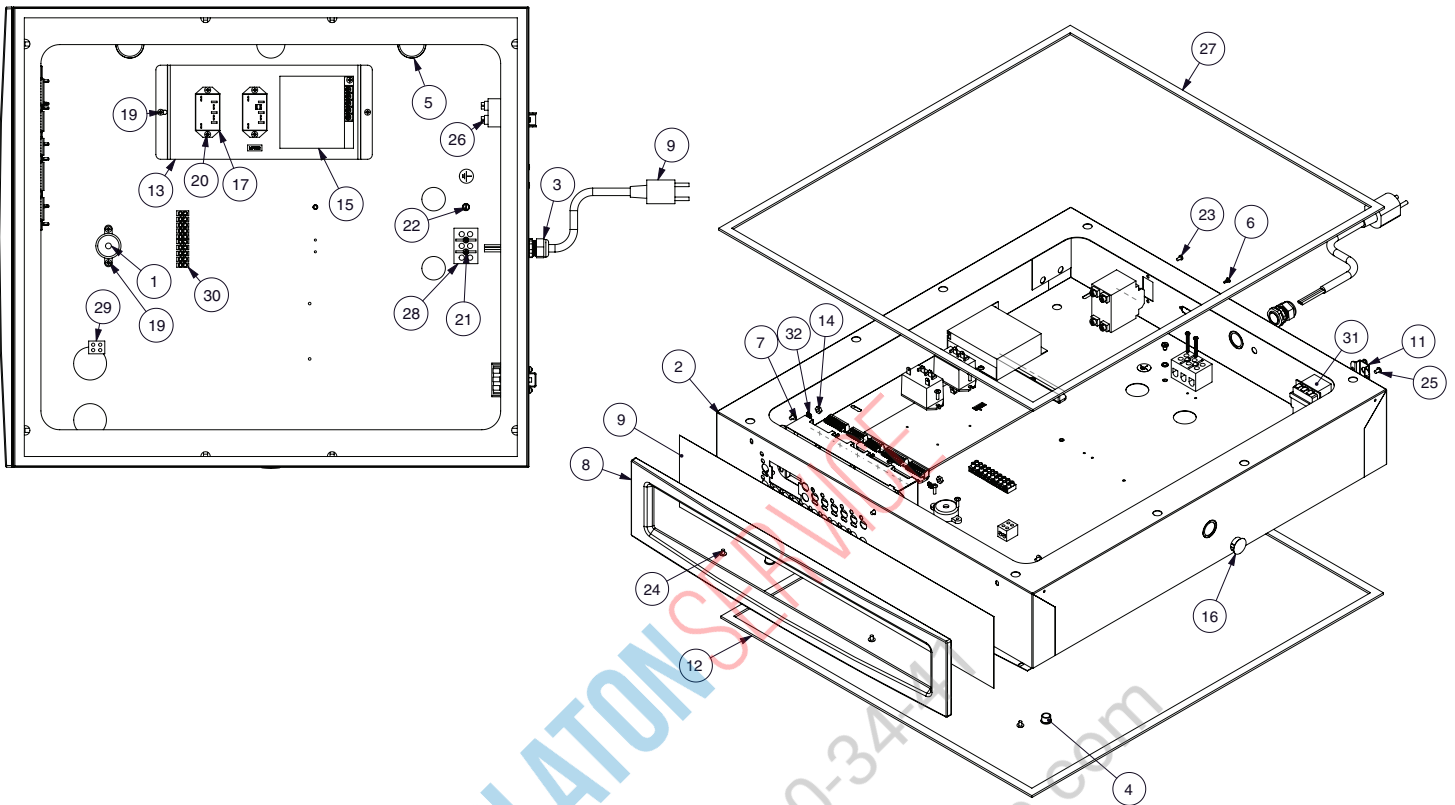

1200-S with Electronic Control - 230V Unit Shown

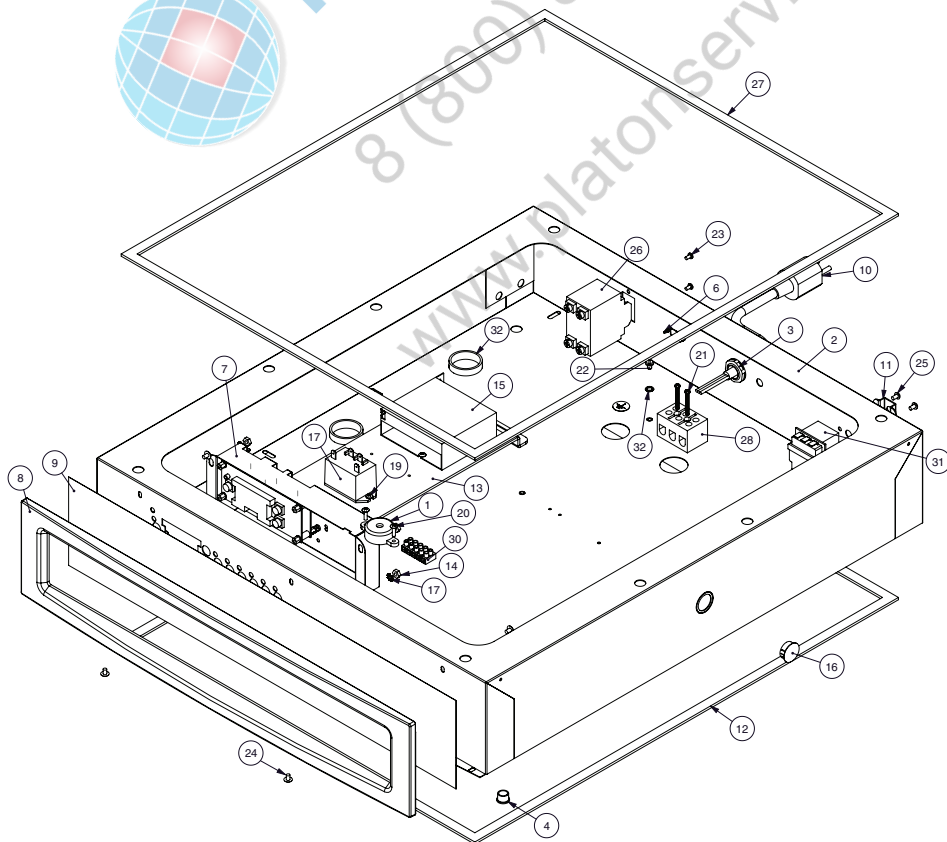

SERVICE

SERVICE PARTS LIST - ELECTRONIC CONTROL

DESCRIPTION	1200-S	1200-UP
1. Beeper	BP-3567	BP-3567
2. Bonnet Assembly	5007801	5007801
3. Bushing, Cord Strain Relief	BU-3964	BU-3964
4. Bushing, Hole 1/2"	BU-3006	BU-3006
5. Bushing, Hole 1-1/2"	BU-3013	BU-3013
6. Clip, Canoe	CL-22820	CL-22820
7. Control, Electronic WITHOUT TIMER WITH TIMER	CC-34322 AVAILABLE	CC-34326 CC-34328
8. Control Panel Bezel	PE-28280	PE-28280
9. Control Panel Overlay, Electronic	PE-28366	PE-27855
10. Cordset, Electronic 120V 208-240V 230V	CD-3397 CD-3551 CD-3922	CD-3397 CD-3551 CD-3922
11. Cover, Hi-Limit Switch	1003936	1003936
12. Gasket, Self Adhesive	GS-2019	GS-2019
13. Heat Sink	1008770	1008770
14. Nut, Hex #8-32	NU-2296	NU-2296
15. Power Supply Board	BA-33554	BA-33554
16. Plug, Hole 13/16"	PG-3589	PG-3589
17. Relay	RL-33558	RL-33558
18. Reed Switch (NOT SHOWN)	SW-33559	SW-33559
19. Screw, Self Tapping 8-32 x 1/2"	SC-25849	SC-25849
20. Screw, 6-32 x 1/2" NC Phil Truss M/S, 18-8 SS	SC-2472	SC-2472
21. Screw, 6-32 x 1-1/4", Round Head	SC-2365	SC-2365
22. Screw, Ground, 10-32 x 1/4" Pan Head	SC-2190	SC-2190
23. Screw, 6-32 x 1/4" Pan Head	SC-22500	SC-22500
24. Screw, 8-32 x 1/4" Phillips	SC-2459	SC-2459
25. Screw, Pan Head M4 x 7mm	SC-22271	SC-22271
26. Sensor (NOT SHOWN)	SN-33541	SN-33541
26. Switch, Circuit Breaker	SW-34077	SW-34077
27. Tape, 1/2" Foam	TA-25621	TA-25621
28. Terminal Block	BK-3019	BK-3019
29. Terminal Block, Porcelain	—	BK-33546
30. Terminal Strip	TM-33560	TM-33560
31. Thermostat, Hi-limit	TT-33476	TT-33476
32. Washer, #8 Ext Lock	WS-2333	WS-2333

VIEW FROM REAR OF BONNET

(FRONT)

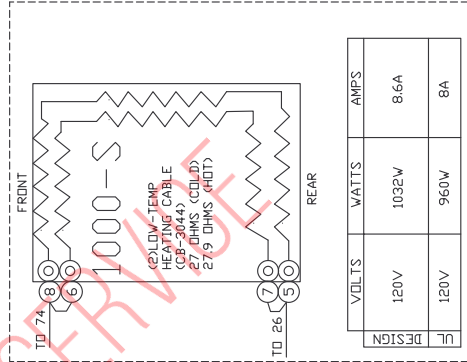
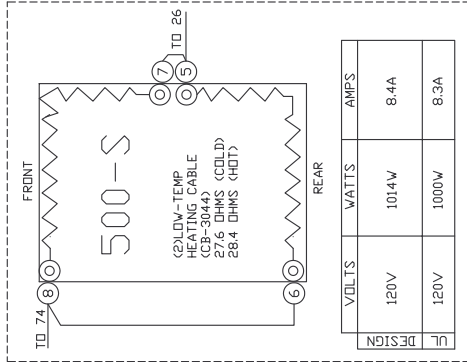
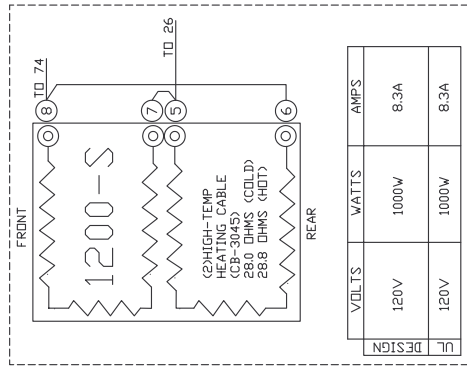
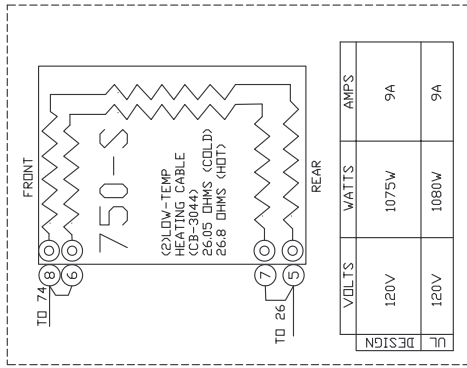
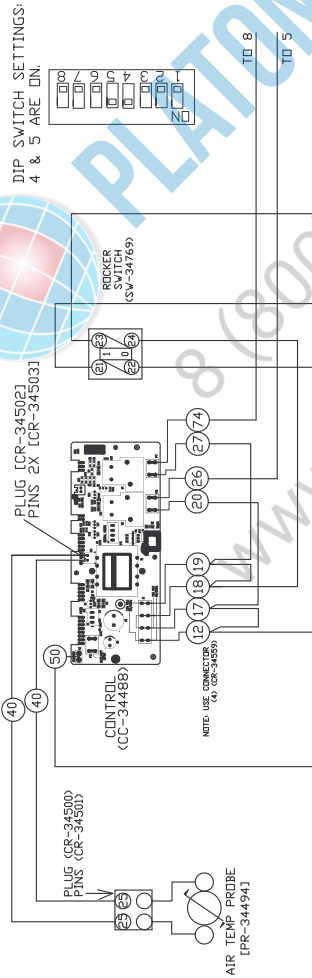

REV	ECO	DESCRIPTION	DATE	APP
4	5406	SWITCH WAS SW-34375	6-18-09	REJ
3	-	ADD 500,750,1000-S	11-24-08	JPK
2	-	MISC. CHANGES	9-3-08	BES

500,750,1000,1200-S 120V 60HZ

AUTO-SHAAM WIRING DIAGRAM

BY: JPK DATE: 1/16/08 DWG: 77194 SHEET 1 OF 1

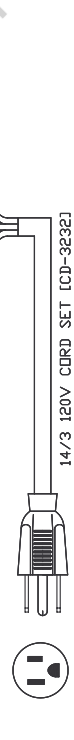

(REAR)

NOTE #1: ALL NUMBERS IN () = ALTO-SHAAM PART NUMBERS
NOTE #2: SEE DRW. 5008760 FOR WIRE ASSEMBLIES

VIEW FROM REAR OF BONNET

(FRONT)

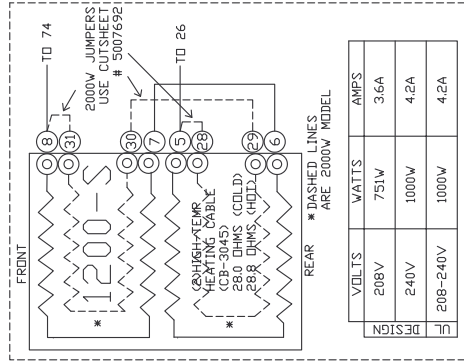
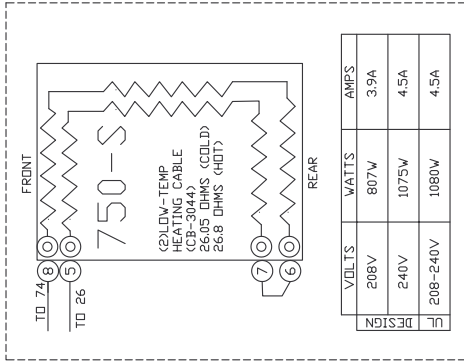
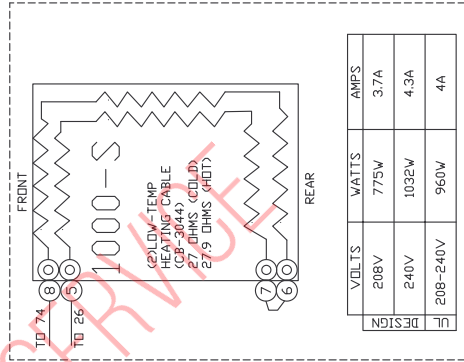
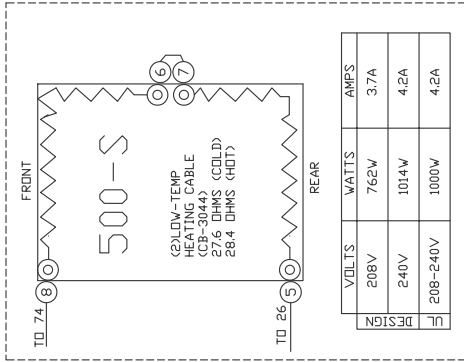
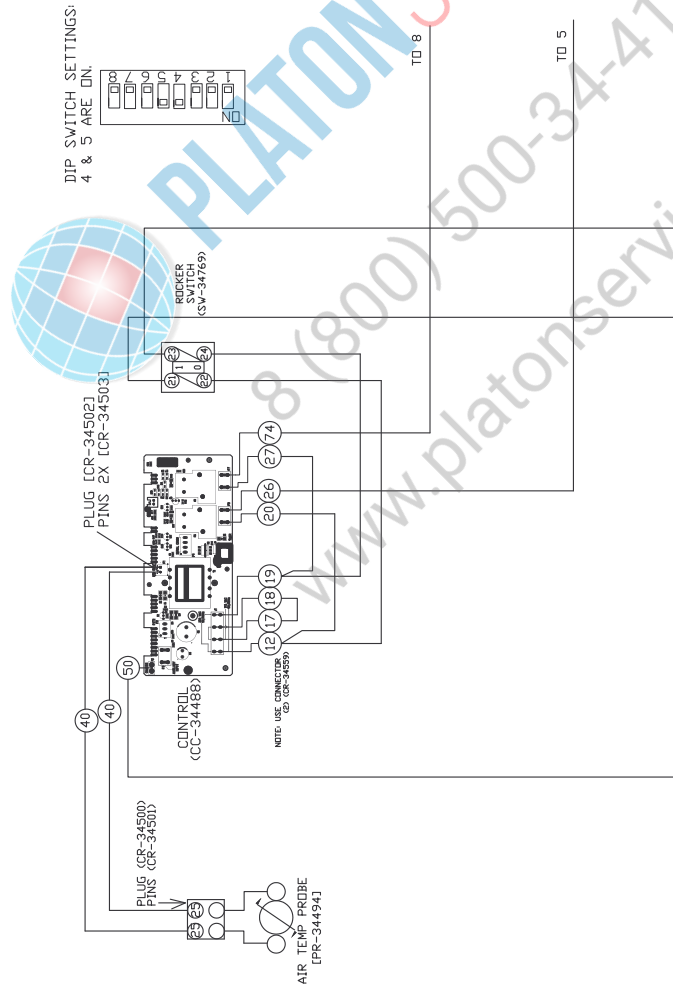

REV	ECO	DESCRIPTION	DATE	APP
3	5406	SWITCH WAS SW-34351	6-18-09	REJ
2	-	ADD 500.750,1000-S	11-24-08	JPK
1	-	RE-DRAW	7-22-08	BES

VOLTS	WATTS	AMPS
208V	1502W	7.2A
240V	2000W	8.4A
208-240V	2000W	8.4A

1200-S, 2000W MODEL

REV	ECO	DESCRIPTION	DATE	APP
3	5406	SWITCH WAS SW-34351	6-18-09	REJ
2	-	ADD 500.750,1000-S	11-24-08	JPK
1	-	RE-DRAW	7-22-08	BES

VOLTS	WATTS	AMPS
208V	1502W	7.2A
240V	2000W	8.4A
208-240V	2000W	8.4A

500.750,1000,1200-S, 208-240V, 60HZ

NOTE #1: ALL NUMBERS IN () = ALTO-SHAAM PART NUMBERS

NOTE #2: SEE DRW. 5008763 FOR MAIN WIRE ASSEMBLY
SEE DRW. 5007692 FOR 2000W JUMPERS

(REAR)

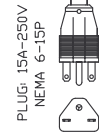

WIRING DIAGRAM
DWG: 77195
BY: JPK DATE: 1/16/08

VIEW FROM REAR OF BONNET

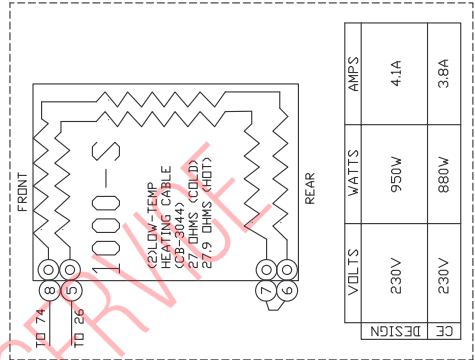
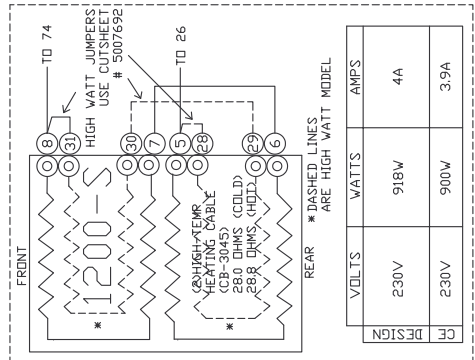
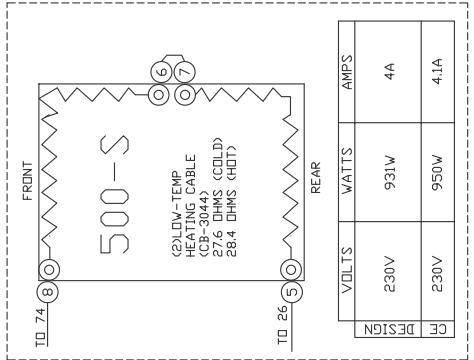
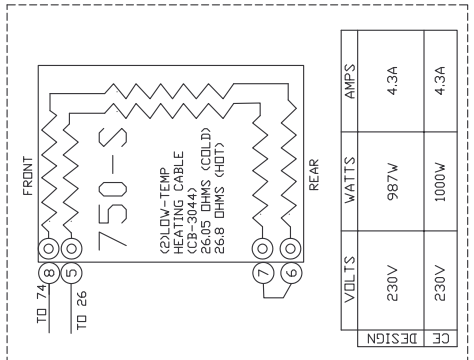
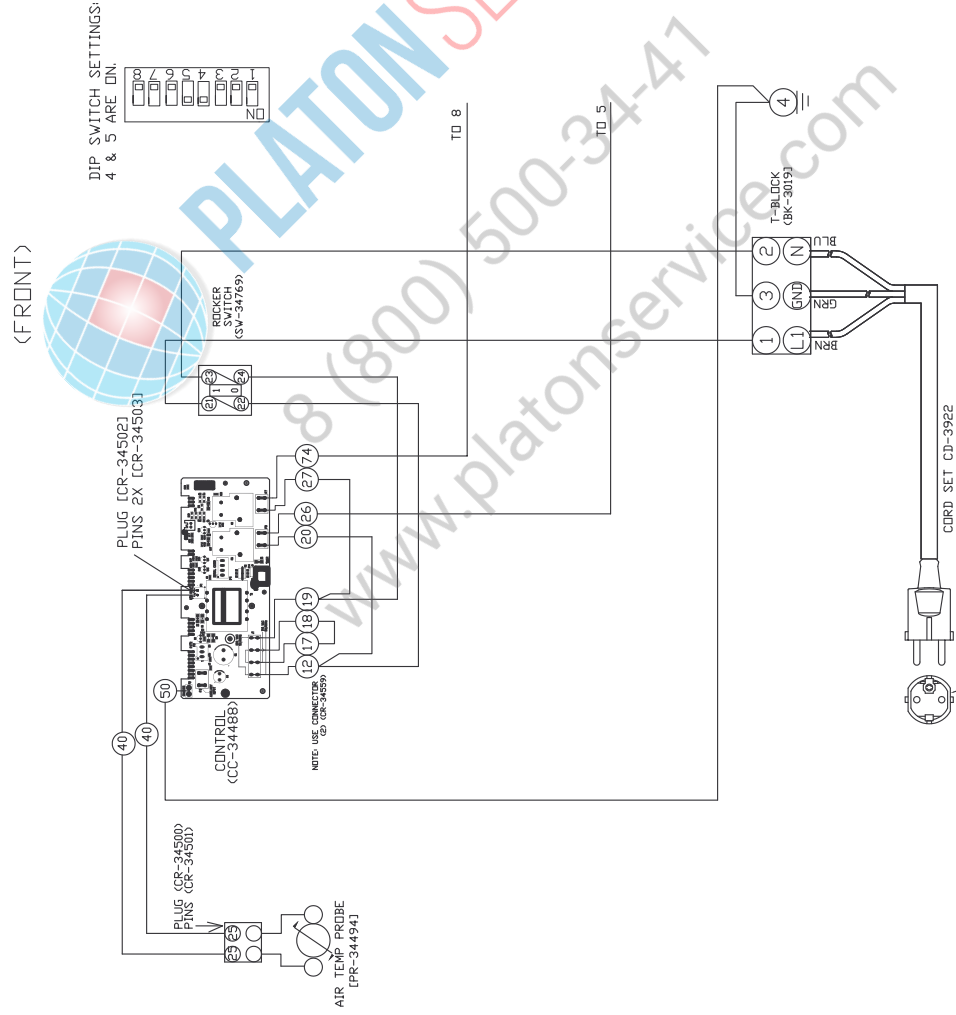

REV	ECO	DESCRIPTION	DATE	APP
5	-	SWITCH WAS SW-34351	6-18-09	REJ
4	-	SWITCH WAS SW-34375	3-11-09	REJ
3	-	ADD 500.750.1000-S	11-24-08	JPK

500.750.1000.1200-S 230V 50HZ

ALTO-SHAAM
DWG: 77196

BY: JPK DATE: 1/16/08

WIRING DIAGRAM

SHEET 1 OF 1

1200-S HIGH WATT MODEL		
VOLTS	WATTS	AMPS
230V	1836W	8A
230V	1800W	7.8A

NOTE #1: ALL NUMBERS IN () = ALTO-SHAAM PART NUMBERS

NOTE #2: SEE DRW 5008765 FOR MAIN WIRE ASSEMBLY
SEE DRW 5007692 FOR HIGH WATT JUMPERS

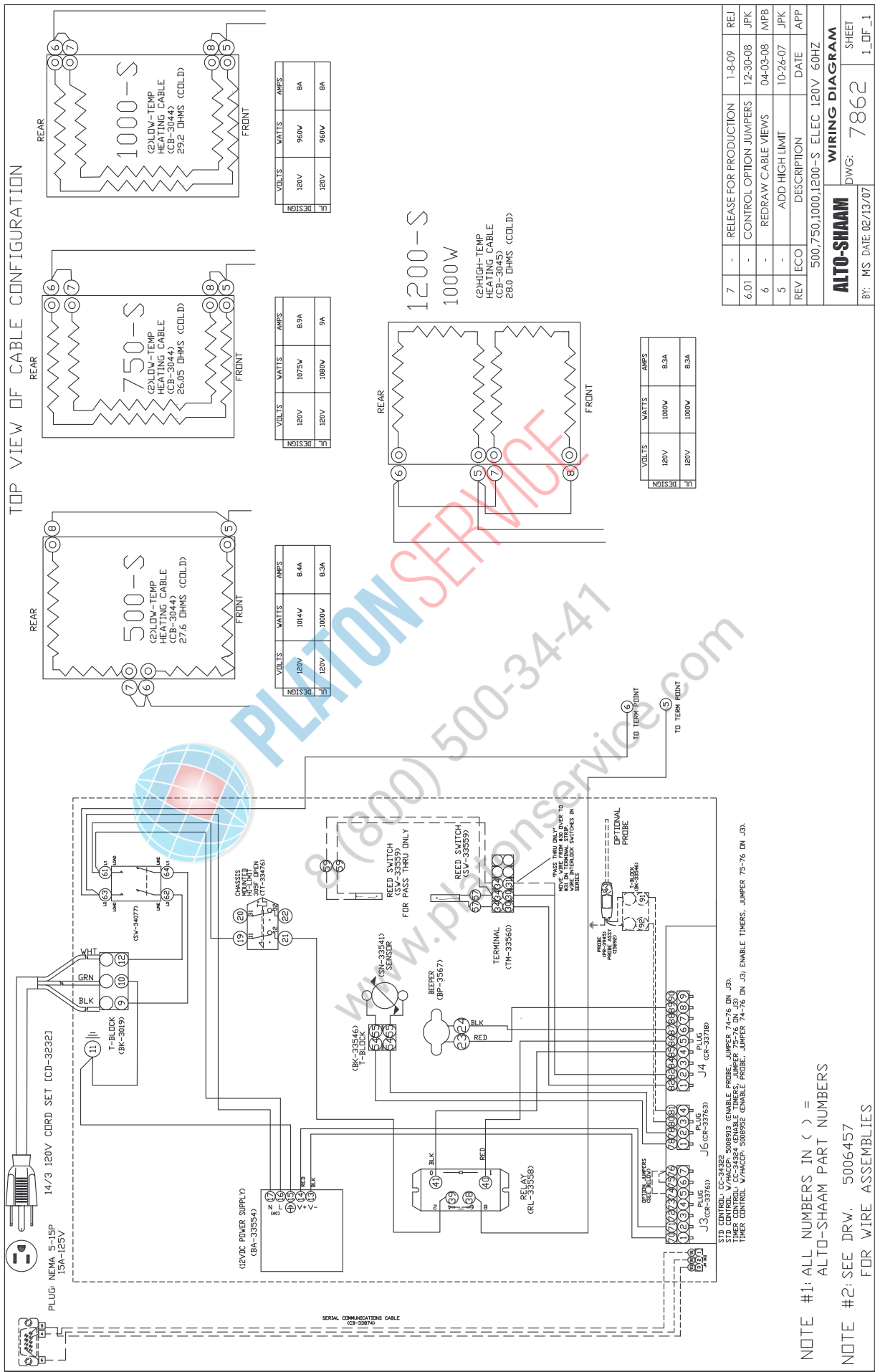

REV	ECO	DESCRIPTION	DATE	APP
7	-	RELEASE FOR PRODUCTION	1-8-09	REJ
6.01	-	CONTROL OPTION JUMPERS	12-30-08	JPK
6	-	REDRAW CABLE VIEWS	04-03-08	MPB
5	-	ADD HIGH LIMIT	10-26-07	JPK

500,750,1000,1200-S ELEC 120V 60HZ

ALTO-SHAAM

BY: MS DATE: 02/13/07 DWG: 7862 SHEET 1_DF_1

TOP VIEW OF CABLE CONFIGURATION

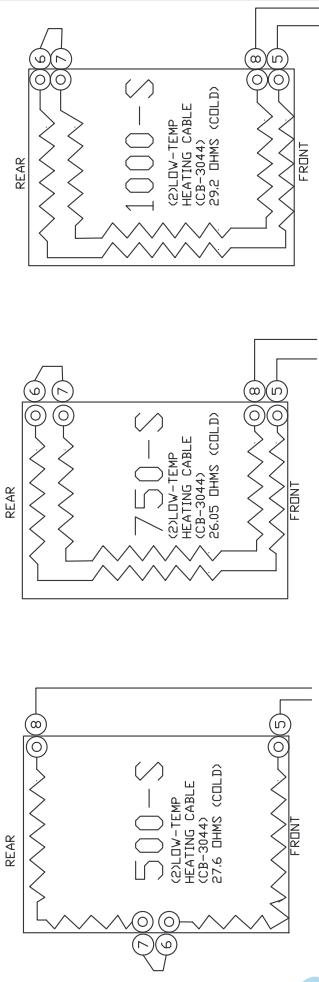

VOLTS	WATTS	AMPS
208V	76W	3.7A
240V	104W	4.2A
208-240V	100W	4.2A

VOLTS	WATTS	AMPS
208V	807W	3.8A
240V	1075W	4.5A
208-240V	1080W	4.5A

VOLTS	WATTS	AMPS
208V	721W	3.5A
240V	960W	4A
208-240V	960W	4A

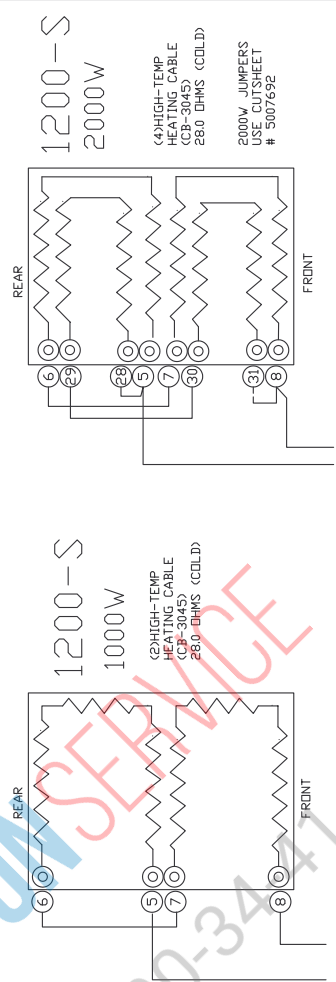

VOLTS	WATTS	AMPS
208V	751W	3.6A
240V	1000W	4.2A
208-240V	1000W	4.2A

VOLTS	WATTS	AMPS
208V	1960W	7.2A
240V	2000W	8.4A
208-240V	X	X

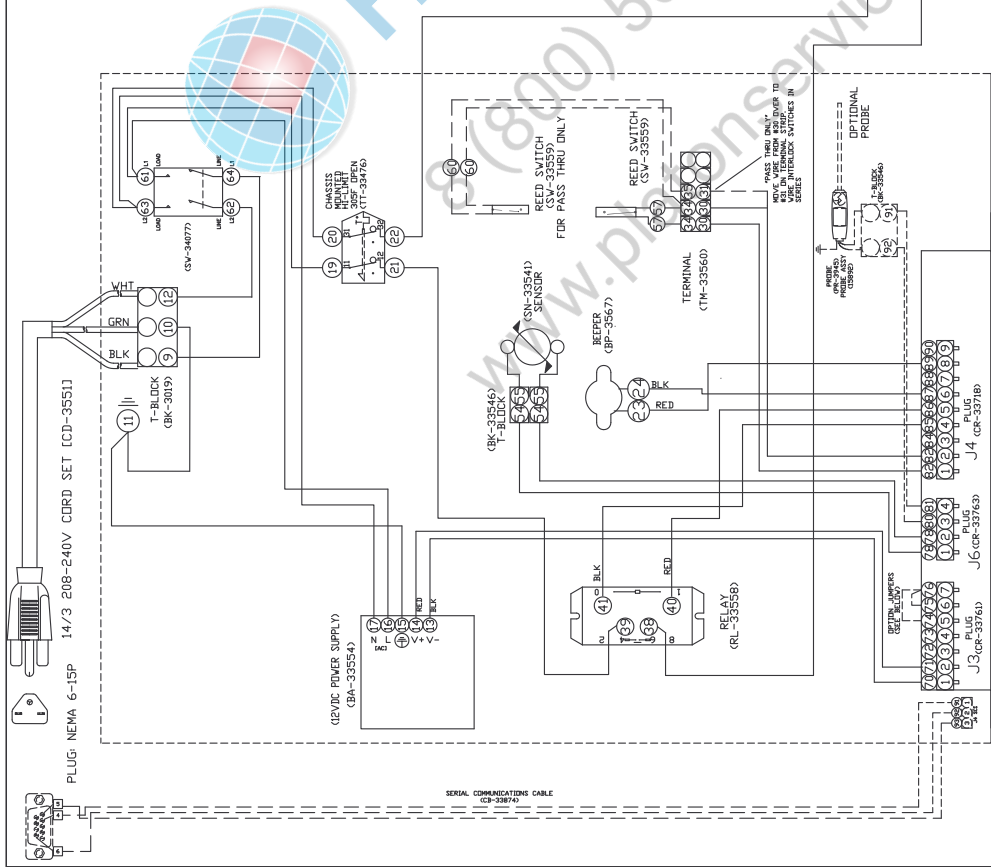

STD CONTROL CC-3432Z 0008912 (ENABLE PROBE, JUMPER 74-76 ON J3)
 TIMER CONTROL CC-34324 (ENABLE TIMERS, JUMPER 75-76 ON J3)
 TIMER CONTROL V/HACCP 508952 (ENABLE PROBE, JUMPER 74-76 ON J3)

NO.	RELEASE FOR PRODUCTION	CONTROL OPTION	JUMPERS
7	-	-	1-8-09 REJ
6.01	-	-	12-30-08 JPK
6	-	-	02-25-08 MPB
5	-	-	10-26-07 JPK
REV	ECO	DESCRIPTION	DATE APP
500,750,1000,1200-S ELEC 208-240V 60HZ			

ALTO-SHAAM
 DWG: 77075
 SHEET 1_OF_1

NOTE #1: ALL NUMBERS IN () = ALTO-SHAAM PART NUMBERS
 NOTE #2: SEE DRW. 5007701 FOR WIRE ASSEMBLIES

TOP VIEW OF CABLE CONFIGURATION

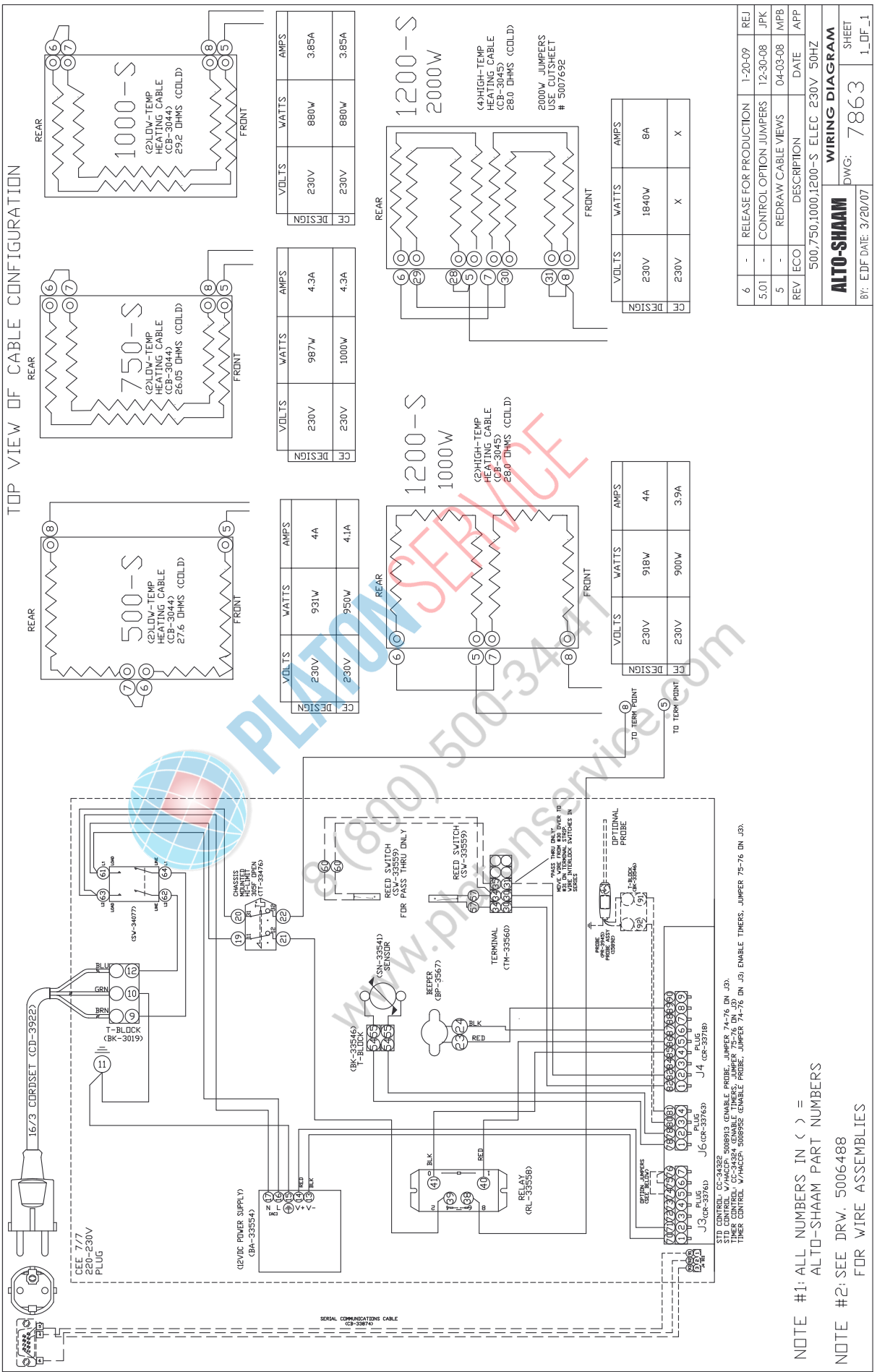

NOTE #1: ALL NUMBERS IN () = ALTO-SHAAM PART NUMBERS

NOTE #2: SEE DRW. 5006488 FOR WIRE ASSEMBLIES

6	-	RELEASE FOR PRODUCTION	1-20-09	REJ
5.01	-	CONTROL OPTION JUMPERS	12-30-08	JPK
5	-	REDRAW CABLE VIEWS	04-03-08	MPB
REV	ECO	DESCRIPTION	DATE	APP
500,750,1000,1200-S ELEC 230V 50HZ				
ALTO-SHAAM				WIRING DIAGRAM
BY: EDF DATE: 3/20/07				DWG: 7863
				SHEET 1_OF_1

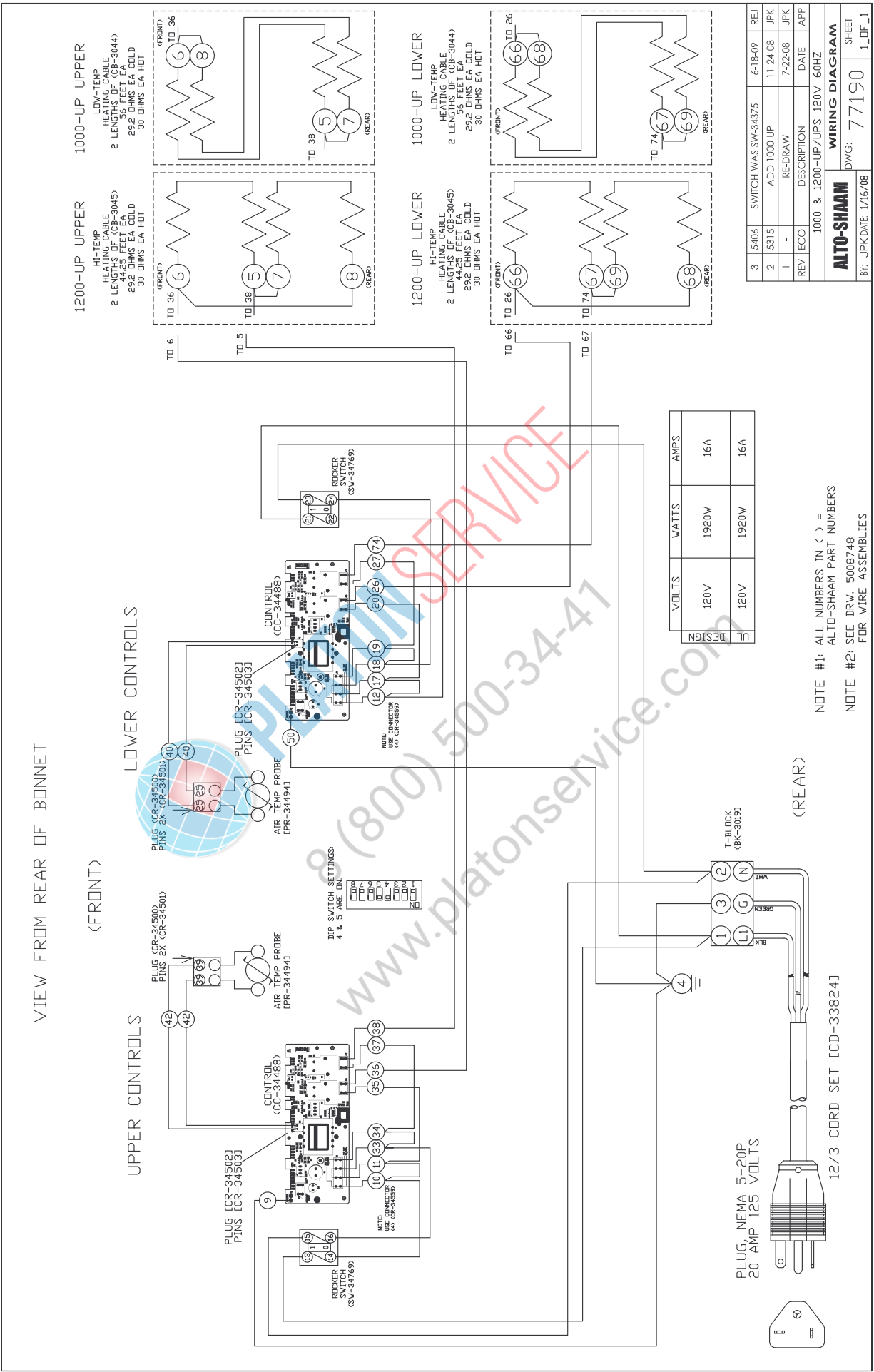

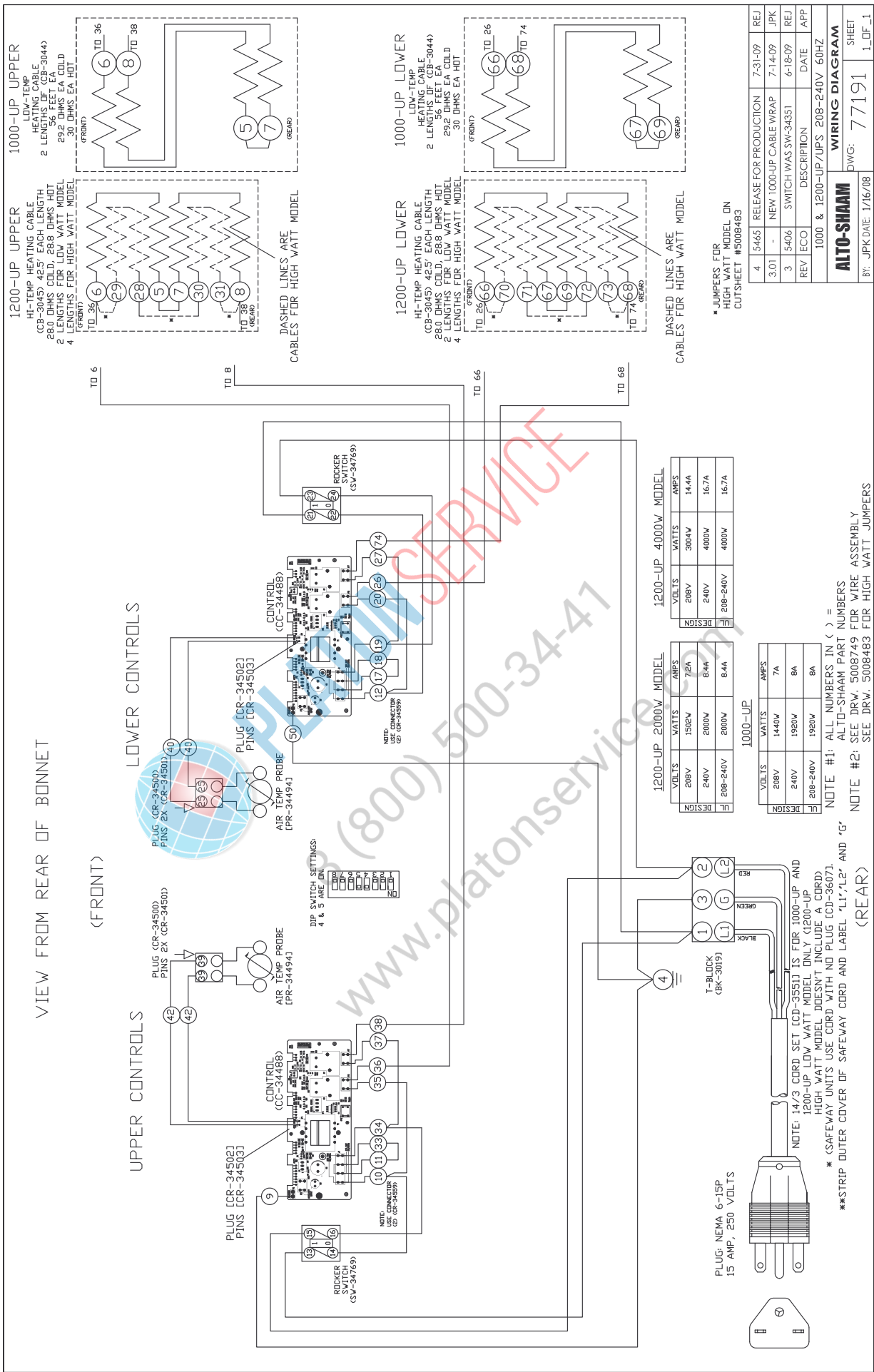

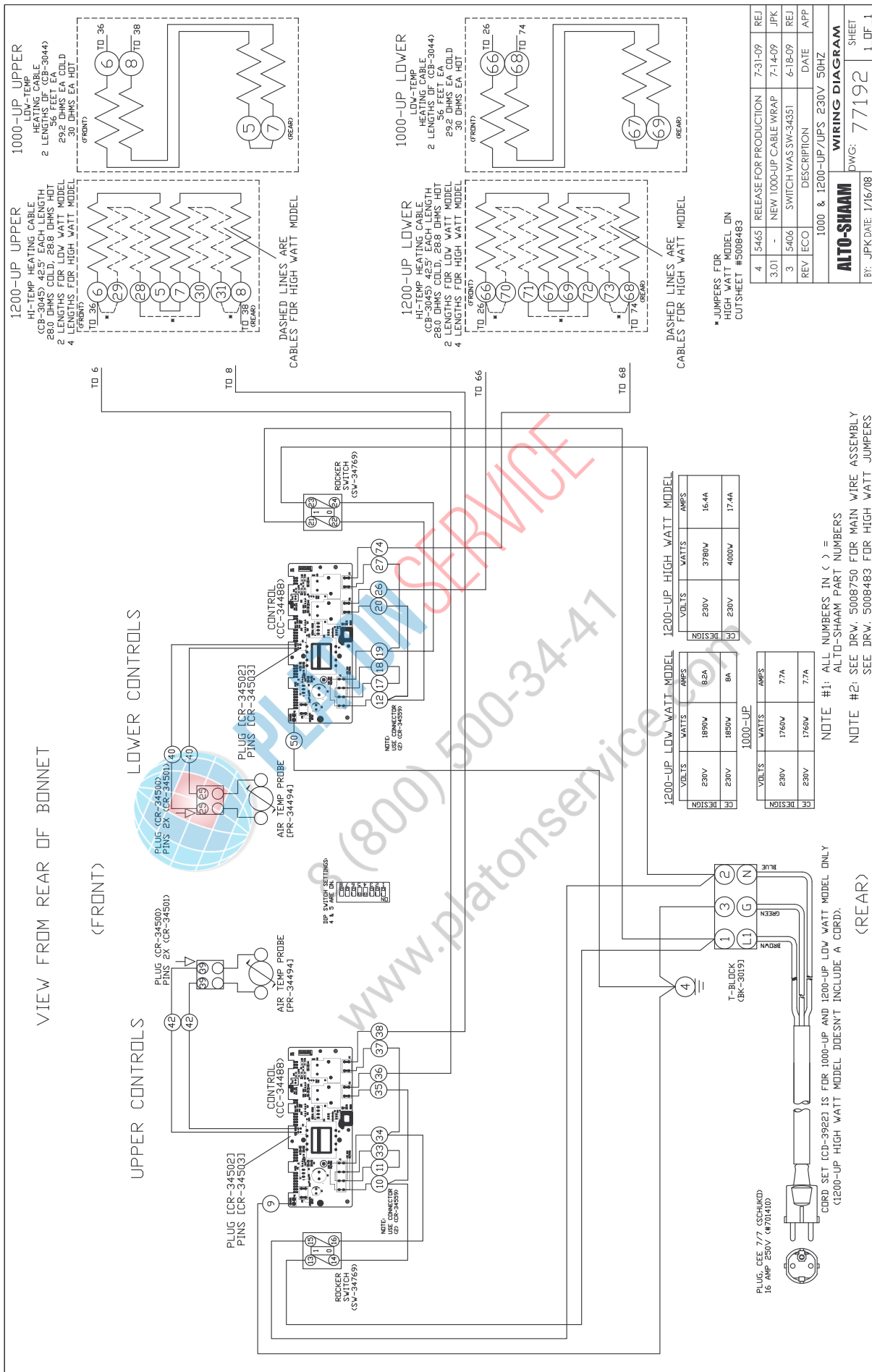

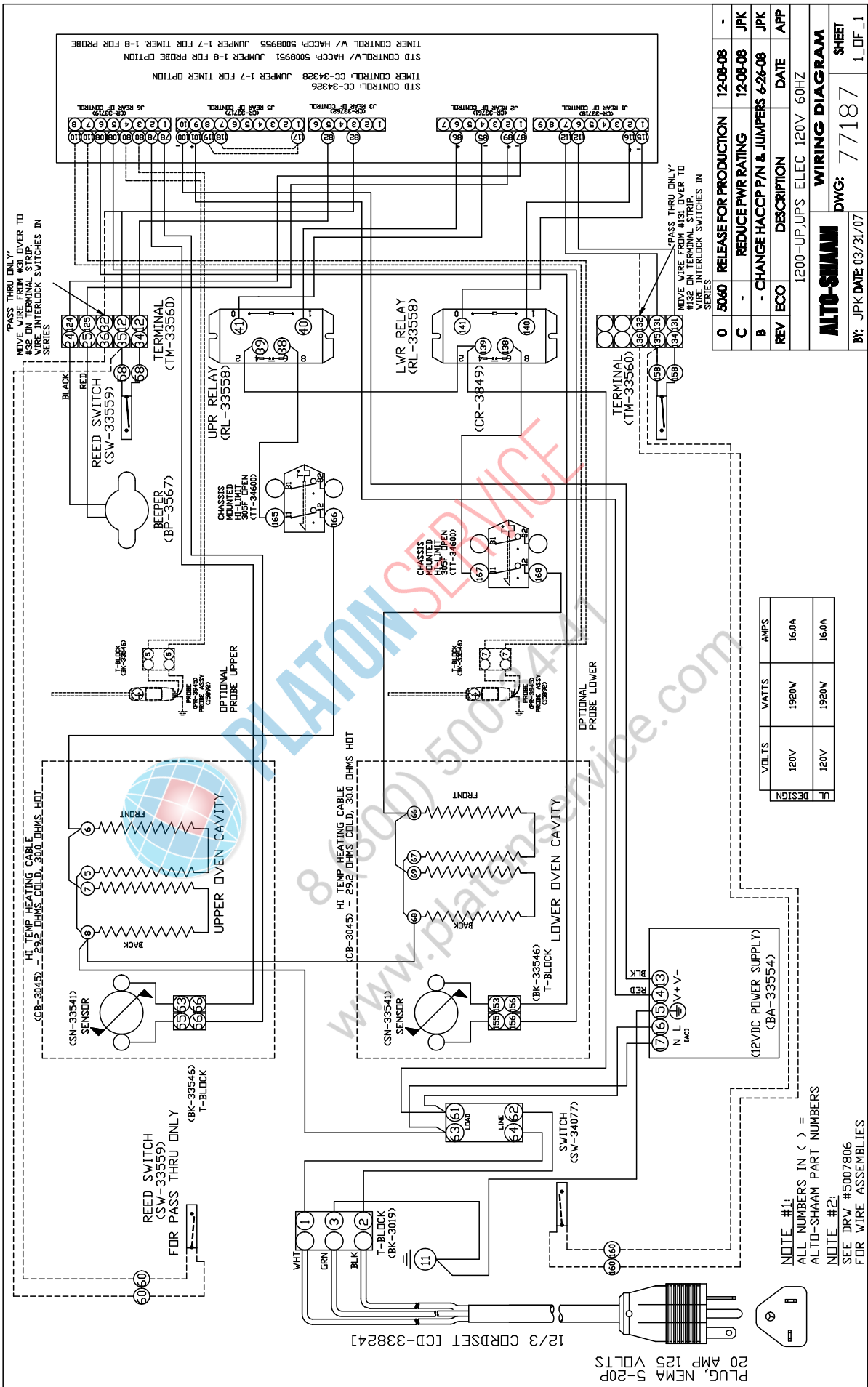

0	5060	RELEASE FOR PRODUCTION	12-08-08	-
C	-	REDUCE PWR RATING	12-08-08	JPK
B	-	CHANGE HACCP P/N & JUMPERS	6-26-08	JPK
REV	ECO	DESCRIPTION	DATE	APP
			1200-UP, UPS	ELEC. 120V 60HZ

ALTO-SUMM
WIRING DIAGRAM
 DWG: 77187
 BY: JPK DATE: 03/31/07

DESIGN	VOLTS	WATTS	AMPS
LF	120V	1950W	16.0A
LF	120V	1920W	16.0A

NOTE #1:
 ALL NUMBERS IN () =
 ALTO-SHAM PART NUMBERS

NOTE #2:
 SEE DRW #5007806
 FOR WIRE ASSEMBLIES

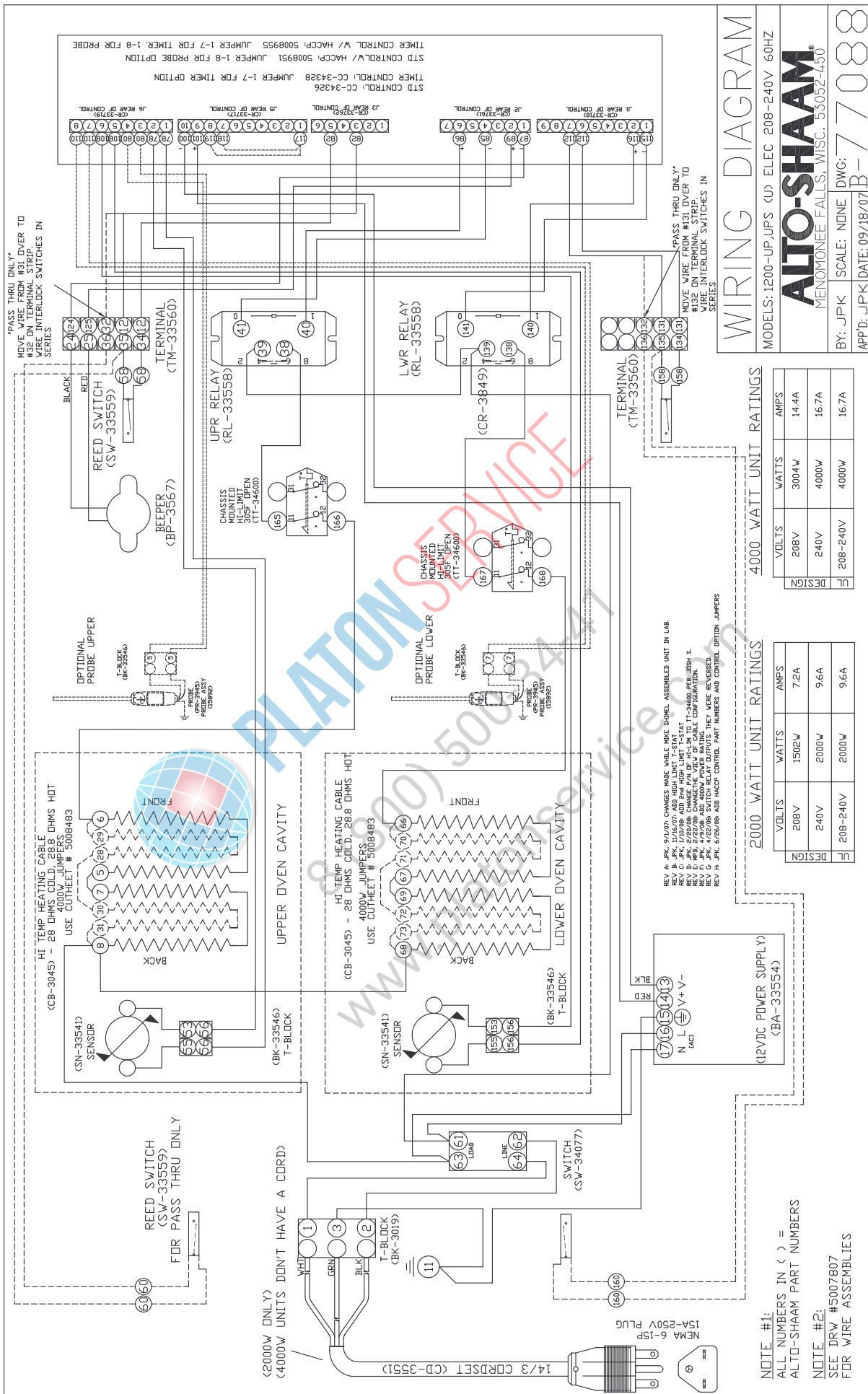

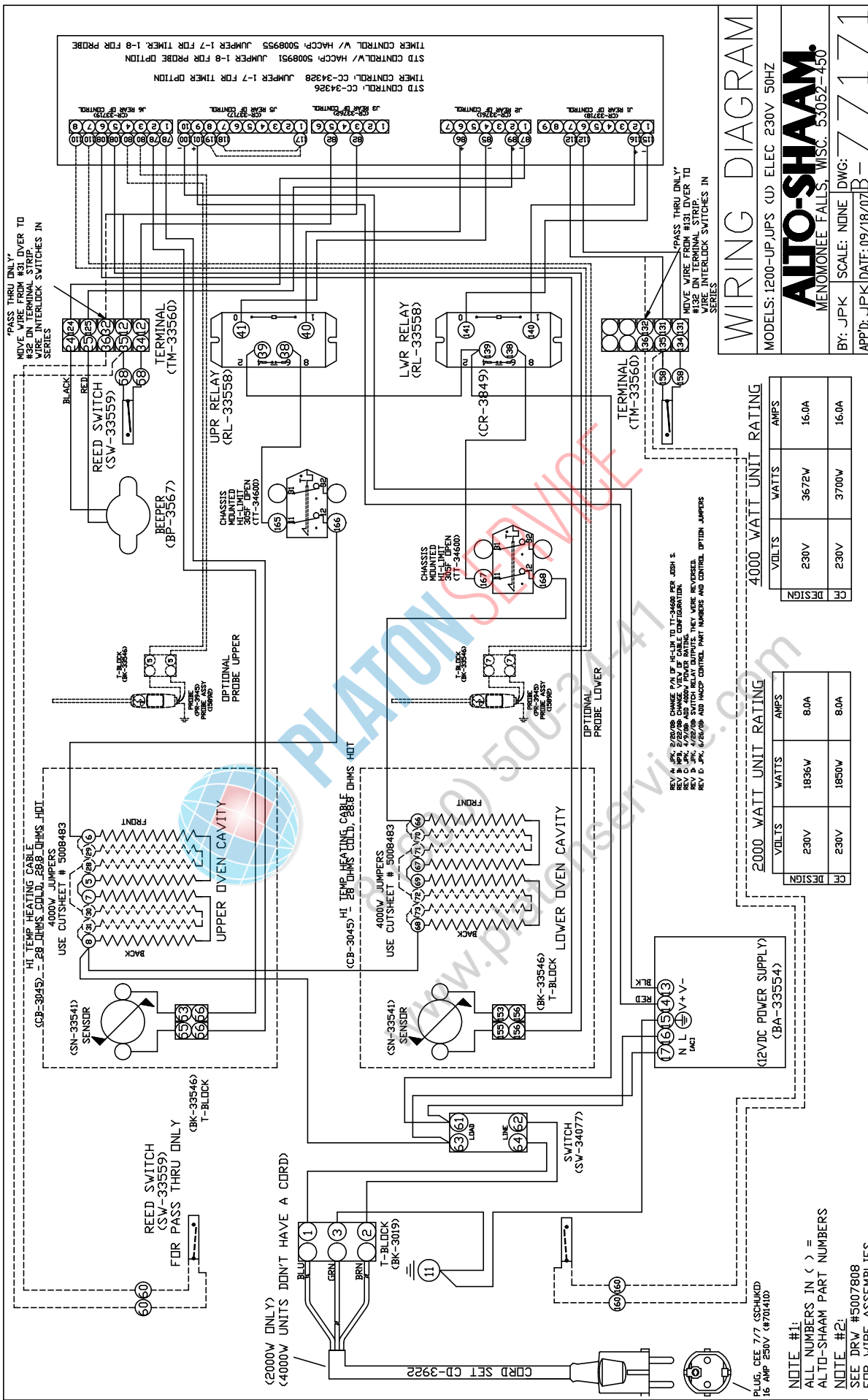

WIRING DIAGRAM

MODELS: 1200-UP, UPS (U) ELEC 230V 50HZ

ALTO-SHAAM
 MEMONONEE FALLS, WISC. 53052-450

BY: JPK SCALE: NONE DWG: B-77171
 APP'D: JPK DATE: 09/18/07

4000 WATT UNIT RATING

VOLTS	WATTS	AMPS
230V	3672W	16.0A
CR	DESIGN	

2000 WATT UNIT RATING

VOLTS	WATTS	AMPS
230V	1836W	8.0A
CR	DESIGN	

REV A JPK 2/20/08 CHANGE P/L UP HI IN TO TT-24608 PER JPK S.
 REV B JPK 2/22/08 CHANGE VOLT OF CABLE CONFIGURATION.
 REV C JPK 4/22/08 SWITCH RELAY OUTPUTS THEY WERE REVERSED.
 REV D JPK 6/15/08 ADD HACCP CONTROL PART NUMBERS AND CONTROL OPTION JUMPERS

NOTE #1:
 ALL NUMBERS IN () =
 ALTO-SHAAM PART NUMBERS

NOTE #2:
 SEE DRW #5007808
 FOR WIRE ASSEMBLIES

TRANSPORTATION DAMAGE and CLAIMS



All Alto-Shaam equipment is sold F.O.B. shipping point, and when accepted by the carrier, such shipments become the property of the consignee.

Should damage occur in shipment, it is a matter between the carrier and the consignee. In such cases, the carrier is assumed to be responsible for the safe delivery of the merchandise, unless negligence can be established on the part of the shipper.

1. Make an immediate inspection while the equipment is still in the truck or immediately after it is moved to the receiving area. Do not wait until after the material is moved to a storage area.
2. Do not sign a delivery receipt or a freight bill until you have made a proper count and inspection of all merchandise received.
3. Note all damage to packages directly on the carrier's delivery receipt.
4. Make certain the driver signs this receipt. If he refuses to sign, make a notation of this refusal on the receipt.
5. If the driver refuses to allow inspection, write the following on the delivery receipt:
Driver refuses to allow inspection of containers for visible damage.
6. Telephone the carrier's office immediately upon finding damage, and request an inspection. Mail a written confirmation of the time, date, and the person called.
7. Save any packages and packing material for further inspection by the carrier.
8. Promptly file a written claim with the carrier and attach copies of all supporting paperwork.

We will continue our policy of assisting our customers in collecting claims which have been properly filed and actively pursued. We cannot, however, file any damage claims for you, assume the responsibility of any claims, or accept deductions in payment for such claims.

LIMITED WARRANTY

Alto-Shaam, Inc. warrants to the original purchaser only that any original part that is found to be defective in material or workmanship will, at Alto-Shaam's option, subject to provisions hereinafter stated, be replaced with a new or rebuilt part.

The parts warranty period is as follows:

For the refrigeration compressor on Alto-Shaam Quickchillers™, five (5) years from the date of installation.

For the heating element on Halo Heat® cook/hold ovens, as long as the original purchaser owns the oven.

For all other parts, one (1) year from the date of installation or fifteen (15) months from the shipping date, whichever occurs first.

The labor warranty period is one (1) year from the date of installation or fifteen (15) months from the shipping date, whichever occurs first.

Alto-Shaam will bear normal labor charges performed during standard business hours, excluding overtime, holiday rates or any additional fees.

To be valid, a warranty claim must be asserted during the applicable warranty period. This warranty is not transferable.

THIS WARRANTY DOES NOT APPLY TO:

1. Calibration.
2. Replacement of light bulbs and/or the replacement of display case glass due to damage of any kind.
3. Equipment damage caused by accident, shipping, improper installation or alteration.
4. Equipment used under conditions of abuse, misuse, carelessness or abnormal conditions, including but not limited to, equipment subjected to harsh or inappropriate chemicals, including but not limited to, compounds containing chloride or quaternary salts, poor water quality, or equipment with missing or altered serial numbers.
5. Damage incurred as a direct result of poor water quality, inadequate maintenance of steam generators and/or surfaces affected by water quality. Water quality and required maintenance of steam generating equipment is the responsibility of the owner/operator.
6. Damage caused by use of any cleaning agent other than Alto-Shaam's Combitherm® Cleaner, including but not limited to damage due to chlorine or other harmful chemicals. **Use of Alto-Shaam's Combitherm® Cleaner on Combitherm® ovens is highly recommended.**
7. Any losses or damage resulting from malfunction, including loss of product or consequential or incidental damages of any kind.
8. Equipment modified in any manner from original model, substitution of parts other than factory authorized parts, removal of any parts including legs, or addition of any parts.

This warranty is exclusive and is in lieu of all other warranties, express or implied, including the implied warranties of merchantability and fitness for a particular purpose. In no event shall Alto-Shaam be liable for loss of use, loss of revenue or profit, or loss of product, or for any indirect, special, incidental, or consequential damages. No person except an officer of Alto-Shaam, Inc. is authorized to modify this warranty or to incur on behalf of Alto-Shaam any other obligation or liability in connection with Alto-Shaam equipment.

Effective 02/09



RECORD THE MODEL AND SERIAL NUMBER OF THE APPLIANCE FOR EASY REFERENCE.
ALWAYS REFER TO BOTH MODEL AND SERIAL NUMBER IN ANY CONTACT WITH ALTO-SHAAM REGARDING THIS APPLIANCE.

Model: _____ Date Installed: _____
Voltage: _____ Purchased From: _____
Serial Number: _____

W164 N9221 Water Street • P.O. Box 450 • Menomonee Falls, Wisconsin 53052-0450 • U.S.A.

PHONE: 262.251.3800 • 800.558-8744 USA/CANADA

FAX: 262.251.7067 • 800.329.8744 U.S.A. ONLY

www.alto-shaam.com

PRINTED IN U.S.A.